

DWX-520

Setup Guide

Read this first

This guide describes the setup tasks and important conditions about the installation site that must be met in order to enable use of this machine.

For the latest information regarding this machine (including manuals), see the DGSHAPE Corporation website (<http://www.dgshape.com/>).



1000025754

Thank you very much for purchasing this product.

- To ensure correct and safe usage with a full understanding of this product's performance, please be sure to read through this manual completely and store it in a safe location.
- Unauthorized copying or transferal, in whole or in part, of this document is prohibited.
- The contents of this document and the specifications of this product are subject to change without notice.
- The operation manual and the product have been prepared and tested as much as possible. If you find any misprint or error, please inform DGSHAPE Corporation.
- DGSHAPE Corporation assumes no responsibility for any direct or indirect loss or damage that may occur through use of this product, regardless of any failure to perform on the part of this product.
- DGSHAPE Corporation assumes no responsibility for any direct or indirect loss or damage that may occur with respect to any article made using this product.

This product's spindle unit

The ZS-4D or ZS-52D spindle unit is attached to this product depending on when it was manufactured.

In the case of the ZS-52D spindle unit, a label is attached to the machine indicating its model number and another label is attached to the spindle unit indicating its model number. No labels are attached to the machine and spindle unit in the case of the ZS-4D.

These spindle units are not compatible, so use the spindle unit matching the model number of the unit attached at the time of purchase. When replacing the spindle unit, use a new one with the correct model number.

Note that this product cannot be used if a spindle unit with the wrong model number is attached.

Applicable EMC Standards: EN 61326-1 (Class A), EN 55011 (Class A, Group 1)

This is a Class A product.

In a domestic environment this product may cause radio interference in which case the user may be required to take adequate measures.

This product is a Group 1 device.

Radio frequency energies in the form of electromagnetic radiation, induction, and/or electrostatic bonding are not used nor deliberately emitted when processing material or during examination/analysis.

For the USA

FEDERAL COMMUNICATIONS COMMISSION RADIO FREQUENCY INTERFERENCE STATEMENT

This equipment has been tested and found to comply with the limits for a Class A digital device, pursuant to Part 15 of the FCC Rules.

These limits are designed to provide reasonable protection against harmful interference when the equipment is operated in a commercial environment.

This equipment generates, uses, and can radiate radio frequency energy and, if not installed and used in accordance with the instruction manual, may cause harmful interference to radio communications.

Operation of this equipment in a residential area is likely to cause harmful interference in which case the user will be required to correct the interference at his own expense.

Unauthorized changes or modification to this system can void the users authority to operate this equipment.

Use only I/O cables that have been designed and manufactured specifically for this device.

For Canada

CAN ICES-3 (A)/NMB-3(A)

NOTICE

Grounding Instructions

In the event of a malfunction or breakdown, grounding provides a path of least resistance for electric current to reduce the risk of electric shock. This tool is equipped with an electric cord having an equipment-grounding conductor and a grounding plug. The plug must be plugged into a matching outlet that is properly installed and grounded in accordance with all local codes and ordinances.

Do not modify the plug provided - if it will not fit the outlet, have the proper outlet installed by a qualified electrician.

Improper connection of the equipment-grounding conductor can result in a risk of electric shock. The conductor with insulation having an outer surface that is green with or without yellow stripes is the equipment-grounding conductor. If repair or replacement of the electric cord or plug is necessary, do not connect the equipment-grounding conductor to a live terminal.

Check with a qualified electrician or service personnel if the grounding instructions are not completely understood, or if in doubt as to whether the tool is properly grounded.

Use only 3-wire extension cords that have 3-prong grounding plugs and 3-pole receptacles that accept the tool's plug.

Repair or replace damaged or worn cord immediately.

For California



WARNING: This product can expose you to chemicals including lead, which is known to the State of California to cause cancer and birth defects or other reproductive harm. For more information go to www.P65Warnings.ca.gov.

For EU Countries



Manufacturer:

DGSHAPE CORPORATION

1-6-4 Shinmiyakoda, Kita-ku, Hamamatsu-shi, Shizuoka-ken, 431-2103 JAPAN

The importer in the EU:

Roland DG EMEA N.V.

Bell Telephonaan 2G, 2440 Geel, Belgium

For UK



Manufacturer:

DGSHAPE CORPORATION

1-6-4 Shinmiyakoda, Kita-ku, Hamamatsu-shi, Shizuoka-ken, 431-2103 JAPAN

The importer in the UK:

Roland DG (U.K.) Ltd.

Griffin House, Windmill Road, Clevedon Business Park, Clevedon, North Somerset, BS21 6UJ, United Kingdom

Operating Instructions

KEEP GUARDS IN PLACE and in working order.

REMOVE ADJUSTING KEYS AND WRENCHES. Form habit of checking to see that keys and adjusting wrenches are removed from tool before turning it on.

KEEP WORK AREA CLEAN. Cluttered areas and benches invite accidents.

DON'T USE IN DANGEROUS ENVIRONMENT. Don't use power tools in damp or wet locations, or expose them to rain. Keep work area well lighted.

KEEP CHILDREN AWAY. All visitors should be kept safe distance from work area.

MAKE WORKSHOP KID PROOF with padlocks, master switches, or by removing starter keys.

DON'T FORCE TOOL. It will do the job better and safer at the rate for which it was designed.

USE RIGHT TOOL. Don't force tool or attachment to do a job for which it was not designed.

USE PROPER EXTENSION CORD. Make sure your extension cord is in good condition. When using an extension cord, be sure to use one heavy enough to carry the current your product will draw. An undersized cord will cause a drop in line voltage resulting in loss of power and overheating.

WEAR PROPER APPAREL. Do not wear loose clothing, gloves, neckties, rings, bracelets, or other jewelry which may get caught in moving parts. Nonslip footwear is recommended. Wear protective hair covering to contain long hair.

USE SAFETY GLASSES, face or dust mask if cutting or cleaning operation is dusty. Everyday eyeglasses only have impact resistant lenses, they are NOT safety glasses.

SECURE WORK. Use clamps or a vise to hold work when practical.

DON'T OVERREACH. Keep proper footing and balance at all times.

MAINTAIN TOOLS WITH CARE. Keep tools sharp and clean for best and safest performance. Follow instructions for lubricating and changing accessories.

DISCONNECT TOOLS before servicing; when changing accessories, such as blades, bits, cutters, and the like.

REDUCE THE RISK OF UNINTENTIONAL STARTING. Make sure switch is in off position before plugging in.

USE RECOMMENDED ACCESSORIES. Consult the owner's manual for recommended accessories. The use of improper accessories may cause risk of injury to persons.

NEVER STAND ON TOOL. Serious injury could occur if the tool is tipped or if the cutting tool is unintentionally contacted.

CHECK DAMAGED PARTS. Before further use of the tool, a guard or other part that is damaged should be carefully checked to determine that it will operate properly and perform its intended function - check for alignment of moving parts, binding of moving parts, breakage of parts, mounting, and any other conditions that may affect its operation. A guard or other part that is damaged should be properly repaired or replaced.

NEVER LEAVE TOOL RUNNING UNATTENDED. TURN POWER OFF. Don't leave tool until it comes to a complete stop.



USE POWER SUPPLY CORD WHICH IS ATTACHED WITH PRODUCTS. do not use other power supply cord.

PERFORM CLEANING USING A DUST COLLECTOR OR A COMMERCIALY AVAILABLE BRUSH. Never use a solvent such as gasoline, alcohol, or thinner to perform cleaning.

CONNECT THE USB CABLE TO THE COMPUTER (Certified with IEC/EN60950-1) with the suitable flammability rating which was estimated by IEC/EN61010-1 3rd Edition (Cl. 9).

USE AN EXTERNAL CABLE AND A DUST COLLECTOR with the suitable flammability rating which was estimated by IEC/EN61010-1 3rd Edition (Cl. 9).

Contents

Contents	3
Machine Highlights	4
Features of This Machine.....	4
Documentation Included with the Machine.....	4
 To Ensure Safe Use	5
 Pour utiliser en toute sécurité	12
Important Notes on Handling and Use	19
Part Names and Functions	20
Preparing the Machine for Use	23
STEP 1: Checking the Included Items	23
STEP 2: Preparing Separate Items	24
STEP 3: Deciding on an Installation Site.....	26
STEP 4: Removing the Retainers	27
STEP 5: Attaching the Dust Collection Hose	29
STEP 6: Attaching the Regulator.....	31
STEP 7: Installing the Software.....	34
STEP 8: Connecting the Cable	37
STEP 9: Switching On the Power Switch	38
STEP 10: Selecting the Machine to Operate with the Control Software	39
STEP 11: Running In the Spindle.....	40
STEP 12: Performing Automatic Correction	42
STEP 13: Switching Off the Power Switch.....	47
Connecting Multiple Units	48
Connection Method.....	48
Changing the Name and Screen of the Machine Displayed on VPanel.....	51
Specifications	52
Expansion Port	52
Power Rating and Serial Number Location.....	53
Coordinates.....	53
Dimensional Drawings	54
Specifications	56

Company names and product names are trademarks or registered trademarks of their respective holders.

<http://www.dgshape.com/>

Copyright © 2021-2022 DGSHAPE Corporation

Machine Highlights

Features of This Machine





This machine is a dental cutting and milling machine that uses zirconia, PMMA, PEEK, composite resin, wax, and dental non-cast cobalt-chromium alloy to make dental prostheses including crowns, copings, and bridges.

Installing and setting up the exclusive software on your computer and connecting your computer to this machine enables you to create high-quality dental prostheses.

For the latest information regarding this machine (including manuals), see the DGSHAPE Corporation website (<http://www.dgshape.com/>).

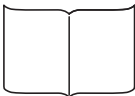
Documentation Included with the Machine

The following documentation is included with the machine.

DWX-52D	
 <p>Setup Guide (this document)</p>	<div style="border: 1px solid black; border-radius: 10px; padding: 5px;"> Be sure to read this first.</div> <ul style="list-style-type: none">• Machine installation procedure• Software installation procedure
 <p>User's Manual (electronic-format manual)</p>	<div style="border: 1px solid black; border-radius: 10px; padding: 5px;"> You can find the manual on the included DGSHAPE Software Package CD. P. 36 "How to View the Electronic-Format Manual"</div> <ul style="list-style-type: none">• Software operation procedure• Milling procedure using the machine• Maintenance procedure

You can view and download the electronic-format manual from the following URL or QR code.

<https://downloadcenter.rolanddg.com/DWX-52D>

* You can also view and download the paper manuals.

* You can also view this website from a smartphone.















To Ensure Safe Use

Improper handling or operation of this machine may result in injury or damage to property. Points which must be observed to prevent such injury or damage are described as follows.

About WARNING and CAUTION Notices

 WARNING	<p>Used for instructions intended to alert the user to the risk of death or severe injury should the unit be used improperly.</p>
 CAUTION	<p>Used for instructions intended to alert the user to the risk of injury or material damage should the unit be used improperly.</p> <p>* Material damage refers to damage or other adverse effects caused with respect to the home and all its furnishings, as well as to domestic animals or pets.</p>

About the Symbols

	<p>The  symbol alerts the user to important instructions or warnings. The specific meaning of the symbol is determined by the design contained within the  symbol. The symbol on the left means "danger of electrical shock."</p>
	<p>The  symbol alerts the user to items that must never be carried out (are forbidden). The specific meaning of the symbol is determined by the design contained within the  symbol. The symbol on the left means "the unit must never be disassembled."</p>
	<p>The  symbol alerts the user to things that must be carried out. The specific meaning of the symbol is determined by the design contained within the  symbol. The symbol on the left means "the power-cord plug must be unplugged from the outlet."</p>

 **Incorrect operation may cause injury**

 **WARNING**

 **Always unplug the power cord when attaching or removing parts and optional parts and when performing cleaning or maintenance that does not require the machine to be connected to a power source.**
Attempting such operations while the machine is connected to a power source may result in injury or electrical shock.

 **Keep children away from the machine.**
The machine includes areas and components that pose a hazard to children and may result in injury, blindness, choking, or some other serious accident.

 **Never attempt to disassemble, repair, or modify the machine.**
Doing so may result in fire, electrical shock, or injury. Entrust repairs to a trained service technician.

 **Be sure to follow the operation procedures described in the user's manual. Never allow anyone unfamiliar with the usage or handling of the machine to touch it.**
Incorrect usage or handling may lead to an accident.

 **Never operate the machine while tired or after ingesting alcohol or any medication.**
Operation requires unimpaired judgment. Impaired judgment may result in an accident.

 **Conduct operations in a clean, brightly lit location.**
Working in a location that is dark or cluttered may lead to an accident, such as becoming caught in the machine as the result of an inadvertent stumble.

 **WARNING**

 **Never climb or lean on the machine.**
The machine is not made to support a person. Climbing or leaning on the machine may dislodge components and cause a slip or fall, resulting in injury.

 **Be careful around the milling tool.**
The milling tool is sharp. Broken milling tools are also dangerous. To avoid injury, exercise caution.

 **Never use a milling tool that has become dull. Perform frequent maintenance to keep the machine in good working order.**
Unreasonable usage may result in fire or injury.

 **Never operate the machine if the cover is cracked or broken.**
Doing so may result in injury. If the cover is cracked or broken, contact your authorized dealer.

 **CAUTION**

 **Remove the milling bur before performing replacement work.**
Contact with the blade may cause injury.

 **This is a heavy machine**

 **CAUTION**



 **Unloading and placement are operations that must be performed by 4 persons or more.**
Tasks that require undue effort when performed by a small number of persons may result in physical injury. Also, if dropped, such items may cause injury.

 **CAUTION**



 **Install the machine in a location that is level, stable, and able to bear the weight of the machine.**
The total weight of the machine may reach 70 kg (155 lb.) or more. Installation in an unsuitable location may cause a major accident, including tip over, fall, or collapse.

 **Milling waste and workpieces are flammable and toxic.**

 **WARNING**



-  **Never attempt to mill magnesium or any other such flammable material.**
Fire may occur during milling.
-  **Never attempt to mill metal, carbon, or any other such conductive material.**
Fire may occur during milling.
-  **Keep open flame away from the work area.**
Milling waste may ignite. Powdered material is extremely flammable, and even metal material may catch fire.

 **WARNING**



-  **Never use a vacuum cleaner to clean up milling waste.**
Picking up fine cuttings using an ordinary vacuum cleaner may result in fire or explosion.
-  **Wear dust goggles and a mask. Wash away any milling waste that gets on your hands.**
Accidentally swallowing or inhaling milling waste may be hazardous to your health.

 **Danger of pinching, entanglement, and burns**

 **WARNING**

-  **Securely fasten the milling tool and workpiece in place. After securing in place, make sure no spanners or other articles have been left behind inadvertently.**
Otherwise, such articles may be thrown from the machine with force, posing a risk of injury.
-  **Do not touch the spindle unit or the surrounding areas immediately after milling has ended.**
Doing so may result in burns.

 **CAUTION**

-  **Do not pull the adapter with excessive force when removing it.**
Doing so may result in injury arising from your hand or arm hitting something.
-  **Never attempt operation while wearing a necktie, necklace, or loose clothing. Bind long hair securely. When performing operations while wearing gloves, exercise sufficient caution to prevent entanglement in the machine.**
Such items may become caught in the machine, resulting in injury.
-  **When opening or closing the front cover, hold the part indicated in the following figure with both hands.**
Failing to do so may result in your fingers being pinched, leading to injury.

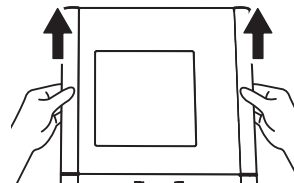



 **Danger of electrical short, electrical shock, or fire**

 **WARNING**

 **Connect to an electrical outlet that complies with this machine's ratings (for voltage, frequency, and current).** Incorrect voltage or insufficient current may cause fire or electrical shock.

 **If sparking, smoke, burning odor, unusual sound, or abnormal operation occurs, immediately unplug the power cord. Never use if any component is damaged.** Continuing to use the machine may result in fire, electrical shock, or injury. Contact your authorized dealer.

 **Never use outside or in any location where exposure to water or high humidity may occur. Do not touch the power cord, plug, or electrical outlet with wet hands.** Doing so may result in fire or electrical shock.

 **Never allow any foreign object to get inside. Never expose the machine to liquid spills.** Inserting objects such as coins or matches or allowing beverages to be spilled into the ventilation ports may result in fire or electrical shock. If anything gets inside, immediately disconnect the power cord and contact your authorized dealer.

 **Never place any flammable object nearby. Never use a combustible aerosol spray nearby. Never use in a location where gases can accumulate.** Combustion or explosion may occur.

 **Handle the power cord, plug, and electrical outlet correctly and with care. Never use any damaged article.** Using a damaged article may result in fire or electrical shock.

 **When using an extension cord or power strip, use one that adequately satisfies the machine's ratings (for voltage, frequency, and current).** Use of multiple electrical loads on a single electrical outlet or use of a lengthy extension cord may cause fire.

 **WARNING**

 **Position so that the power plug is within immediate reach at all times.** This is to enable quick disconnection of the power plug in the event of an emergency. Install the machine next to an electrical outlet. Also, provide enough empty space to allow immediate access to the electrical outlet.

 **For accessories (optional and consumable items, power cord, and the like), use only genuine articles compatible with this machine.** Incompatible items may lead to an accident.

 **Never use the machine for any purpose for which it is not intended, and never use the machine in an undue manner that exceeds its capacity.** Doing so may result in injury or fire.

 **Do not use the supplied power cord for other products.**

 **If the machine is not used for long hours, disconnect the power cord.** This prevents an accident caused by unexpected electric leakage or unintentional start of the machine.

 **Connect to ground.** This can prevent fire or electrical shock due to current leakage in the event of a malfunction.

 **Never use cutting oil.** This machine was not designed for the flow of cutting oil. Oil may get inside the machine and cause fire or electrical shock.

 **Never use a pneumatic blower.** This machine is not compatible with a pneumatic blower. Milling waste may get inside the machine and cause fire or electrical shock.

 **Important notes about the power cord, plug, and electrical outlet**

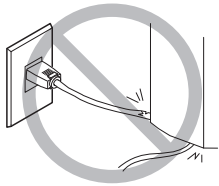

Never place any object on top or subject to damage.

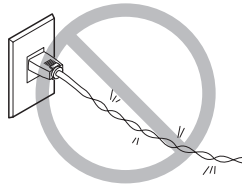

Never bend or twist with undue force.



Never pull with undue force.

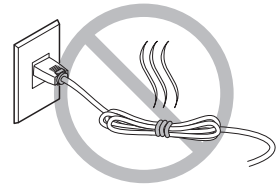

Never bundle, bind, or roll up.



Never allow to get wet.

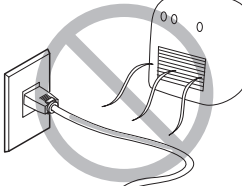

Never make hot.

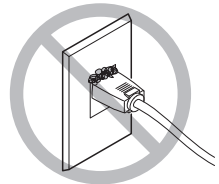

Dust may cause fire.

 **Danger of components flying off or becoming damaged**

 **WARNING**



Ensure that the supplied compressed air is not contaminated by water, oil, chemicals, or foreign objects.
The components may deteriorate or rupture, or the contaminants may be scattered, posing a hazard.



Never use the machine in a location exposed to cutting oil, solvents, chemicals, or other such substances.
Components may deteriorate or rupture under the pressure of compressed air.



Never use the machine in a location exposed to direct sunlight.
Components may deteriorate or rupture under the pressure of compressed air.



Keep the temperature of the installation area within the specified range. Never place a stove or heater nearby.
Components may deteriorate or rupture under the pressure of compressed air.

 **WARNING**



Connect the air hose securely, so that it will not come loose.
A pressurized hose that comes loose may whip about uncontrolled, posing a hazard. Connect securely.



Before attempting to attach or detach the air hose or optional items or before attempting to perform cleaning or maintenance that does not require the machine to be connected to a power source, stop the supply of compressed air and allow the pressure to escape.
Allowing the equipment to remain under pressure poses a hazard of flying components.



Use an air hose with the specified diameter and with adequate pressure resistance.
Otherwise, the hose may come loose or rupture.

 **Danger of components flying off or becoming damaged**

 **WARNING**

 **Keep the supply of compressed air within the specified pressure range.**
Exceeding the specified pressure may result in a rupture or other major accident.

 **Never strike or subject the object to impacts.**
Components may become damaged or rupture under the pressure of compressed air.

 **WARNING**

 **When the machine will be out of use for a prolonged period, stop supply of compressed air and bleed off the air pressure.**
This can prevent an accident.

 **Never damage the air hose, or bend or twist it with undue force. Never use any deteriorated article.**
A damaged air hose may rupture.

 **Important notes about the end (cut edge) of the air hose**

Failure to observe these cautions may result in air leakage or easy dislodgement of the air hose. Also, after removing a hose, cut off the end before reattaching it.

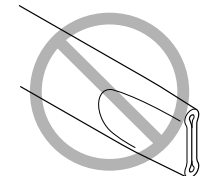
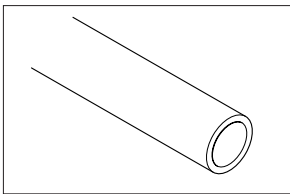

Ensure that the hose is not crushed.

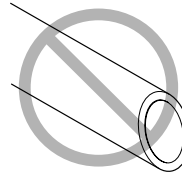

Make the cut edge straight.

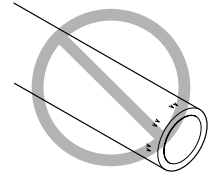

Keep free of damage and soiling.

 **Warning Labels**

Warning labels are affixed to make areas of danger immediately clear. The meanings of these labels are as follows. Be sure to heed their warnings. Also, never remove the labels or allow them to become obscured.

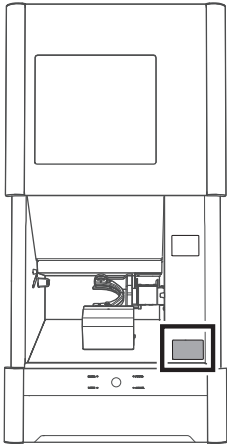

Caution: Sharp Tool
The milling tool has a sharp point. Inadvertent contact may cause injury.



Never use a pneumatic blower.
This machine is not compatible with a pneumatic blower. Milling waste may get inside the machine and cause fire or electrical shock.

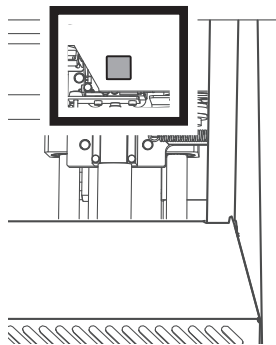

Caution: High temperatures
Do not touch the spindle unit or the surrounding areas immediately after milling has ended. Doing so may result in burns.

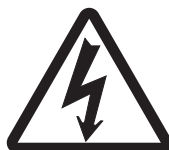
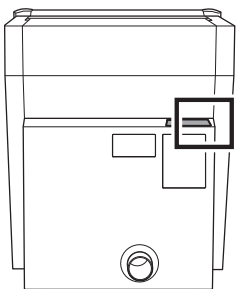



Caution: High Voltage
Removing the cover may result in high-voltage electric shock.









Pour utiliser en toute sécurité

La manipulation ou l'utilisation inadéquates de cet appareil peuvent causer des blessures ou des dommages matériels. Les précautions à prendre pour prévenir les blessures ou les dommages sont décrites ci-dessous.

Avis sur les avertissements

 ATTENTION	Utilisé pour avertir l'utilisateur d'un risque de décès ou de blessure grave en cas de mauvaise utilisation de l'appareil.
 PRUDENCE	Utilisé pour avertir l'utilisateur d'un risque de blessure ou de dommage matériel en cas de mauvaise utilisation de l'appareil. * Par dommage matériel, il est entendu dommage ou tout autre effet indésirable sur la maison, tous les meubles et même les animaux domestiques.

À propos des symboles

	Le symbole  attire l'attention de l'utilisateur sur les instructions importantes ou les avertissements. Le sens précis du  symbole est déterminé par le dessin à l'intérieur du triangle. Le symbole à gauche signifie « danger d'électrocution ».
	Le symbole  avertit l'utilisateur de ce qu'il ne doit pas faire, ce qui est interdit. Le sens précis du  symbole est déterminé par le dessin à l'intérieur du triangle. Le symbole à gauche signifie que l'appareil ne doit jamais être démonté.
	Le symbole  prévient l'utilisateur sur ce qu'il doit faire. Le sens précis du  symbole est déterminé par le dessin à l'intérieur du triangle. Le symbole à gauche signifie que le fil électrique doit être débranché de la prise.



Une utilisation incorrecte peut causer des blessures



ATTENTION



Toujours débrancher le câble d'alimentation lors de la fixation ou du retrait de pièces et de pièces en option et du nettoyage ou des travaux d'entretien qui n'exigent pas un branchement de l'appareil à une source d'alimentation.

Tenter ces opérations pendant que l'appareil est branché à une source d'alimentation peut causer des blessures ou un choc électrique.



ATTENTION



Garder les enfants loin de l'appareil.

L'appareil comporte des zones et des composants qui présentent un danger pour les enfants et qui pourraient causer des blessures, la cécité, la suffocation ou d'autres accidents graves.

 Une utilisation incorrecte peut causer des blessures

 **ATTENTION**



Ne jamais tenter de démonter, de réparer ou de modifier l'appareil.

Le non-respect de cette consigne risque de provoquer un incendie, un choc électrique ou des blessures. Confier les réparations à un technicien ayant la formation requise.



S'assurer de suivre les procédures d'utilisation décrites dans le manuel utilisateur.

Ne jamais permettre à quiconque ne connaissant pas le fonctionnement ou la manutention de l'appareil de le toucher. L'utilisation ou la manutention incorrectes peuvent causer un accident.



Ne jamais faire fonctionner l'appareil après avoir consommé de l'alcool ou des médicaments, ou dans un état de fatigue.

L'utilisation de l'appareil exige un jugement sans faille. L'utilisation avec les facultés affaiblies pourrait entraîner un accident.



Utiliser l'appareil dans un endroit propre et bien éclairé.

Travailler dans un endroit sombre ou encombré peut causer un accident; l'utilisateur risque, par exemple, de trébucher malencontreusement et d'être coincé par une partie de l'appareil.

 **ATTENTION**



Ne jamais grimper ni s'appuyer sur la machine.

La machine n'est pas conçue pour supporter le poids d'une personne. Grimper ou s'appuyer sur la machine peut déplacer des éléments et causer un faux pas ou une chute, ce qui causerait des blessures.



Être attentif dans le périmètre de l'outil de coupe.

L'outil de coupe est acéré. Les outils de coupes brisés sont aussi dangereux. Faire preuve de prudence pour éviter les blessures.



Ne jamais utiliser un outil de coupe émoussé. Procéder fréquemment aux travaux d'entretien pour garder l'appareil en bon état de fonctionnement.

L'usage inapproprié peut causer un incendie ou des blessures.



Ne pas utiliser si un couvercle avant est fissuré ou brisé.

Vous risqueriez de vous blesser. Si le couvercle est fissuré ou brisé, communiquer avec le représentant autorisé.

 **PRUDENCE**



Retirer l'outil de coupe avant de procéder aux travaux de remplacement.

Un contact avec la lame peut provoquer une blessure.

 Cet appareil est lourd.

 **PRUDENCE**



Le déchargement et la mise en place doivent être faits par au moins quatre personnes.

Les tâches qui exigent un effort trop grand si elles sont exécutées par un petit nombre de personnes peuvent être cause de blessures. La chute d'articles très lourds peut aussi causer des blessures.

 **PRUDENCE**





Installer l'appareil à un endroit de niveau, stable et pouvant prendre en charge le poids l'appareil.

Le poids total de la machine peut atteindre 70 kg (155 lb) ou plus. Installer l'appareil à un endroit inapproprié peut provoquer un accident grave comme le renversement, la chute ou l'effondrement.

 **Les rebuts et morceaux de la coupe sont inflammables et toxiques.**

 **ATTENTION**

 **Ne jamais tenter de couper du magnésium ni aucun autre matériau inflammable.**
Un incendie pourrait se produire pendant la coupe.

 **Ne jamais essayer de couper du métal, du carbone ou tout autre métal conducteur.**
Un incendie pourrait se produire pendant la coupe.

 **Ne pas approcher une flamme nue de l'espace de travail.**
Les rognures de coupe peuvent s'enflammer. Les matériaux pulvérisés sont extrêmement inflammables et même le métal peut s'enflammer.

 **ATTENTION**

 **Ne jamais utiliser un aspirateur pour aspirer des rognures de coupe.**
L'utilisation d'un aspirateur normal pour aspirer des rognures finement coupées peut entraîner un risque d'incendie ou d'explosion.

 **Porter des lunettes de protection et un masque. Rincer toutes les rognures de coupe qui pourraient rester collées aux mains.**
Ingérer ou respirer accidentellement des rognures de coupe peut être dangereux pour la santé.

 **Certains éléments peuvent présenter un risque de pincement, d'emmêlement, de brûlure ou d'autres dangers.**

 **ATTENTION**

 **Fixer solidement l'outil de coupe et la pièce à travailler. Une fois qu'ils sont fixés solidement, s'assurer qu'aucun outil ni aucun autre objet n'a été laissé en place.**
Si tel était le cas, ces objets pourraient être projetés avec force hors de l'appareil et causer des blessures.

 **Attention : températures élevées. L'outil de coupe et le moteur chauffent.**
Faire preuve de prudence pour éviter un incendie ou des brûlures.

 **PRUDENCE**

 **Ne pas utiliser de force excessive lors du retrait de l'adaptateur.**
Le non-respect de cette consigne peut provoquer des blessures causées par un impact sur votre main ou votre bras.

 **Ne jamais utiliser l'appareil avec des cravates, des colliers ou des vêtements amples. Les cheveux longs doivent être solidement attachés. Lors du fonctionnement de l'appareil et tout en portant des gants, faire preuve d'assez de prudence pour prévenir l'emmêlement dans l'appareil.**
Tous ces objets peuvent être attrapés dans l'appareil, risquant de provoquer des blessures.

 **Lors l'ouverture ou de la fermeture du couvercle avant, tenir la pièce indiquée à la figure suivante avec les deux mains.**
Le non-respect de cette consigne peut mener au pincement de vos doigts et entraîner une blessure.

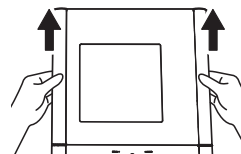



 **Risque de décharge ou de choc électrique, d'électrocution ou d'incendie**

 **ATTENTION**

 **Brancher à une prise électrique conforme aux caractéristiques de cet appareil (tension, fréquence et courant).**
Une tension incorrecte ou un courant insuffisant peuvent causer un incendie ou un choc électrique.

 **S'il se produit des étincelles, de la fumée, une odeur de brûlé, des bruits inhabituels ou un fonctionnement anormal, débrancher immédiatement le câble d'alimentation.**
Ne jamais utiliser si un composant est endommagé. Continuer à utiliser l'appareil peut causer un incendie, un choc électrique ou des blessures. Communiquer avec le représentant autorisé.

 **Ne jamais utiliser à l'extérieur ni à un endroit où l'appareil risque d'être exposé à de l'eau ou à une humidité élevée. Ne pas toucher le câble d'alimentation, la fiche ou la prise électrique avec des mains mouillées.**
Le non-respect de cette consigne risque de provoquer un incendie ou un choc électrique.

 **Ne jamais insérer d'objet étranger dans l'appareil. Ne jamais exposer l'appareil aux déversements de liquides.**
L'insertion d'objets comme des pièces de monnaie ou des allumettes ou le déversement de liquides dans les orifices de ventilation peuvent causer un incendie ou un choc électrique. Si un objet ou du liquide s'infiltré dans l'appareil, débrancher immédiatement le câble d'alimentation et communiquer avec le représentant autorisé.

 **Ne jamais placer d'objet inflammable à proximité de l'appareil. Ne jamais utiliser de produit inflammable en aérosol à proximité de l'appareil. Ne jamais utiliser l'appareil dans un endroit où des gaz peuvent s'accumuler.**
Une combustion ou une explosion pourraient se produire.

 **ATTENTION**

 **Manipuler le câble d'alimentation, la fiche et la prise électrique correctement et avec soin.**
Ne jamais utiliser un article endommagé, car cela pourrait causer un incendie ou un choc électrique.

 **Si une rallonge ou une bande d'alimentation électrique sont utilisées, s'assurer qu'elles correspondent aux caractéristiques de l'appareil (tension, fréquence et courant).**
L'utilisation de plusieurs charges électriques sur une prise unique ou une longue rallonge peut causer un incendie.

 **Placer l'appareil de façon à ce que la fiche soit facile d'accès en tout temps.**
Ainsi, l'appareil pourra être débranché rapidement en cas d'urgence. Installer l'appareil près d'une prise électrique. En outre, prévoir suffisamment d'espace pour que la prise électrique soit facile d'accès.

 **Utiliser uniquement des accessoires d'origine (accessoires en option, articles consommables, câble d'alimentation et autres articles semblables), compatibles avec l'appareil.**
Les articles incompatibles risquent de causer des accidents.

 **Ne jamais utiliser l'appareil à des fins autres que celles pour lesquelles il est conçu. Ne jamais l'utiliser de manière abusive ou excessive.**
Le non-respect de cette consigne peut causer des blessures ou un incendie.

 **Ne pas utiliser le cordon électrique fourni avec d'autres produits.**

 **Si l'appareil doit rester inutilisé pendant une longue période, débrancher le câble d'alimentation.**
Cela peut prévenir les accidents en cas de fuite de courant ou de démarrage accidentel.

⚠ Risque de décharge ou de choc électrique, d'électrocution ou d'incendie



Mise à la terre.

La mise à la terre peut prévenir un incendie ou un choc électrique dus à une fuite de courant en cas de défaillance.



Ne jamais utiliser d'air sous pression.

Cet appareil n'est pas conçu pour être nettoyé à l'aide d'un appareil soufflant. Des rognures de coupe peuvent s'infiltrer à l'intérieur et causer un incendie ou un choc électrique.



Ne jamais utiliser d'huile de coupe.

Cet appareil n'est pas conçu pour traiter l'huile de coupe. L'huile peut s'infiltrer à l'intérieur et causer un incendie ou un choc électrique.

⚠ Remarques importantes à propos du câble d'alimentation, de la fiche et de la prise électrique

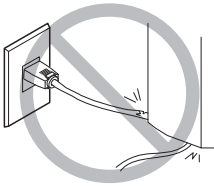

Ne jamais déposer aucun objet dessus au risque de les endommager.

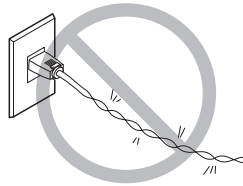

Ne jamais plier ni enrouler.



Ne jamais tirer avec une force excessive.

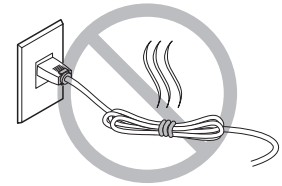

Ne jamais plier ni tordre avec une force excessive.

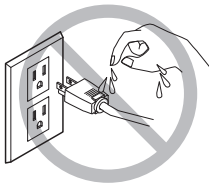

Ne jamais laisser mouiller.

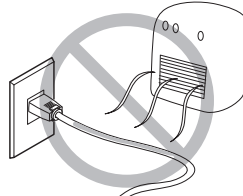

Ne jamais chauffer.

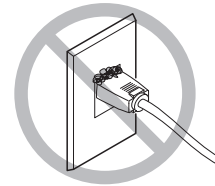

La poussière peut causer un incendie.

⚠ Composants risquant d'être éjectés ou endommagés



ATTENTION



S'assurer que l'air comprimé n'est pas contaminé par de l'eau, de l'huile, des produits chimiques ou des objets étrangers.

Les composants pourraient se détériorer ou se rompre et les contaminants pourraient être projetés; cela représente un risque.



ATTENTION



Ne jamais utiliser dans un endroit exposé directement aux rayons du soleil.

Les composants pourraient se détériorer ou se rompre sous la pression de l'air comprimé.



Ne jamais utiliser dans un endroit exposé à de l'huile de coupe, des solvants, des produits chimiques ou d'autres substances similaires.

Les composants pourraient se détériorer ou se rompre sous la pression de l'air comprimé.

⚠ Composants risquant d'être éjectés ou endommagés

⚠ ATTENTION

❗ **Garder la température de l'endroit où l'appareil est installé dans les limites spécifiées. Ne jamais placer un four ou un appareil de chauffage à proximité.**
Les composants pourraient se détériorer ou se rompre sous la pression de l'air comprimé.

❗ **Connecter solidement le tuyau à air pour éviter qu'il se détache.**
Un tuyau sous pression qui se détache peut fouetter l'air de manière désordonnée et créer une situation dangereuse.
Le fixer solidement.

❗ **Avant de fixer ou de retirer le tuyau à air ou des accessoires en option ou avant de procéder au nettoyage ou à un entretien qui n'exige pas un branchement de l'appareil à une source d'alimentation, couper l'arrivée d'air comprimé et laisser la pression s'échapper.**
Si l'équipement est laissé sous pression, il y a risque que des éléments soient projetés.

❗ **Utiliser un tuyau à air du diamètre spécifié et ayant une résistance appropriée à la pression.**
Sinon, le tuyau risque de se détacher ou de se rompre.

❗ **Garder l'alimentation en air comprimé à la pression spécifiée.**
Appliquer une pression supérieure à la pression spécifiée risque de rompre le tuyau ou de causer un accident grave.

⚠ ATTENTION

⊘ **Ne jamais frapper ni soumettre l'objet à un impact.**
Les composants pourraient être endommagés ou se rompre sous la pression de l'air comprimé.

❗ **Si l'appareil doit rester inutilisé pendant une longue période, couper l'alimentation en air comprimé et purger la pression.**
Cette précaution peut prévenir un accident.

⊘ **Ne jamais endommager le tuyau à air, le plier ou le tordre avec une force excessive. Ne jamais utiliser un article détérioré.**
Un tuyau à air endommagé risque de se rompre.

⚠ Remarques importantes relativement à l'extrémité (bord coupé) du tuyau à air.

Le non-respect de ces consignes de sécurité peut causer une fuite d'air ou le débranchement du tuyau à air. En outre, si le tuyau à air a été débranché, en couper l'extrémité avant de le rebrancher.

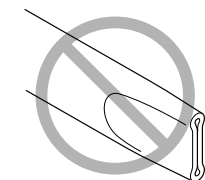
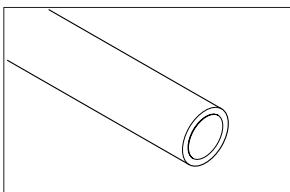

S'assurer qu'il n'est pas écrasé

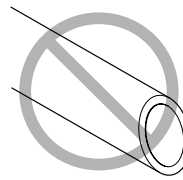

Le bord coupé doit être droit

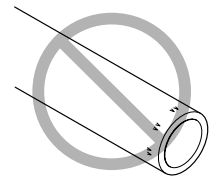

Le garder en bon état et propre

Vignettes d'avertissement

Des vignettes d'avertissement sont apposées pour qu'il soit facile de repérer immédiatement les zones dangereuses. La signification des vignettes est donnée ci-dessous. Respecter les avertissements. Ne jamais retirer les vignettes et ne pas les laisser s'encrasser.

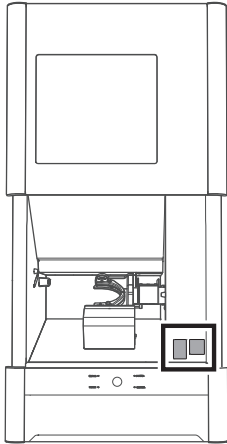

Attention : outil coupant
L'outil de coupe est acéré.
L'utilisation incorrecte peut causer des blessures



Ne jamais utiliser d'air sous pression.
Cet appareil n'est pas conçu pour être nettoyé à l'aide d'un appareil soufflant. Des rognures de coupe peuvent s'infiltrer à l'intérieur de l'appareil et causer un incendie ou un choc électrique.

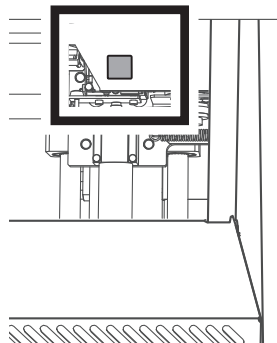

Attention : Température élevée
Ne pas toucher au fuseau ou près du fuseau.
Vous risqueriez de vous brûler.

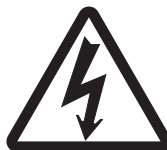
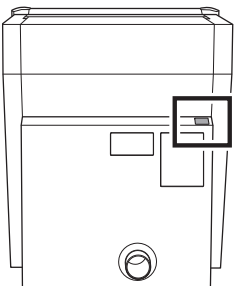

Attention : voltage élevé
Il peut être dangereux de retirer le couvercle puisqu'il y aurait des risques de chocs électriques à cause du voltage élevé.

Important Notes on Handling and Use

This machine is a precision device. To ensure the full performance of this machine, be sure to observe the following important points. Failure to observe these points may not only result in loss of performance but may also cause malfunction or breakdown.

This machine is a precision device.

- Handle this machine carefully and never subject it to impacts or excessive force.
- Carefully clean away milling waste.
- Use this machine within the range of its specifications.
- Never attempt to move the spindle unit or rotary axis unit by hand with undue force.
- Never needlessly touch anywhere inside the machine except for locations specified in this manual.

Install this machine in a suitable location.

- Install this machine in a location that meets the specified conditions for temperature, humidity, and the like.
- Install this machine in a quiet, stable location offering good operating conditions.
- Never install this machine outside.
- Never install this machine in an environment where silicone substances (oil, grease, spray, etc.) are present. Doing so may cause poor switch contact or ionizer damage.

This machine becomes hot.

- Never cover the ventilation holes with cloth or anything else.
- Install this machine in a well-ventilated location.

About workpieces that can be milled with this machine

The following workpieces can be milled with this machine. Do not cut workpieces that are not listed below.

- Zirconia
- PMMA, PEEK, composite resin
- Wax
- Dental non-cast cobalt-chromium alloy

About the milling bur

The tip of the milling bur is breakable. Handle the milling bur with care, being careful not to drop it.

Part Names and Functions

Front (Milling Section)

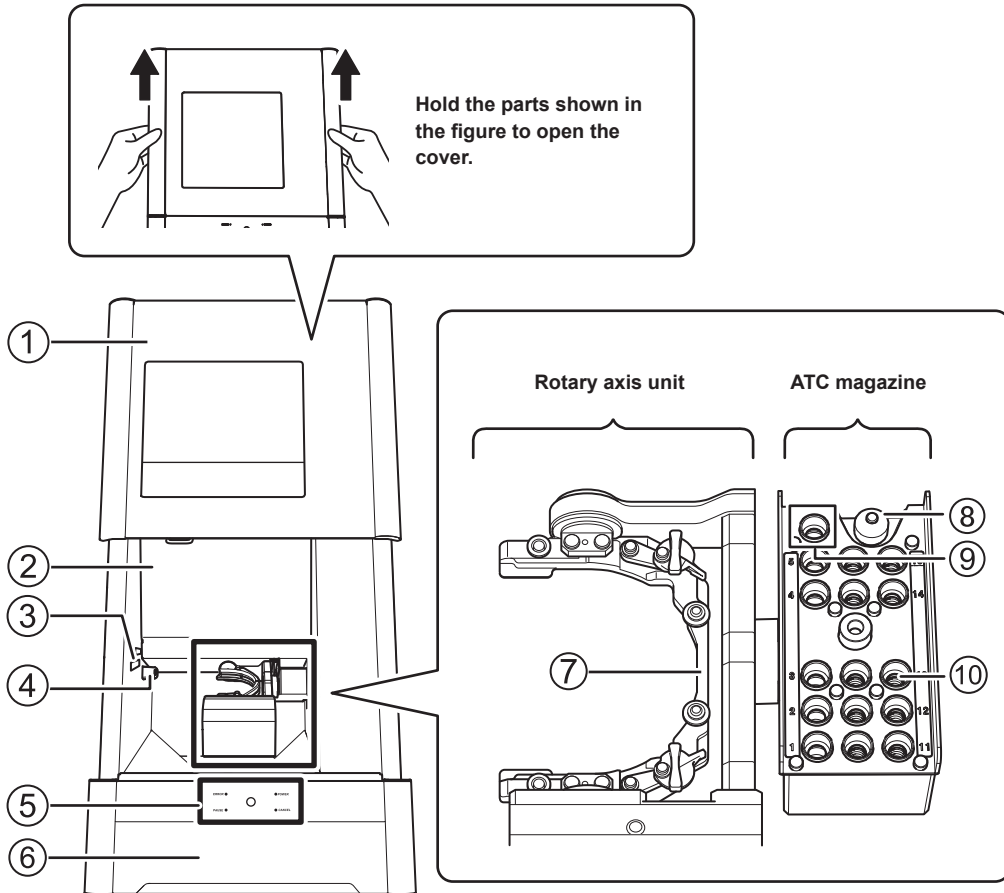

Number	Name	Number	Name	Number	Name
①	Front cover*	⑤	Built-in panel	⑨	Cleaning tool stocker
②	Maintenance cover	⑥	Bottom cover	⑩	Milling bur Stocker
③	Status light	⑦	Clamp		
④	Ionizer**	⑧	Milling bur sensor		

* To ensure safety, opening the cover during spindle rotation causes an emergency stop.

** The ionizer works to eliminate static electricity from milling waste when cutting PMMA.

In order to ensure the effectiveness of the ionizer, connect this machine to ground.

Inside the Maintenance Cover

Open the cover to replace the spindle or perform other work.

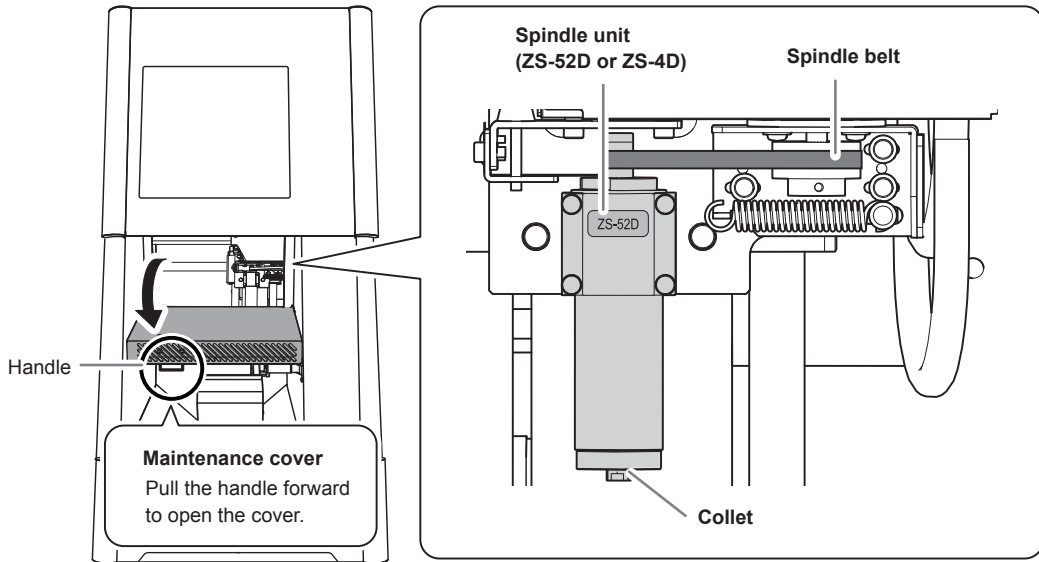

Inside the Bottom Cover (Storage)

Included items and milling burs can be stored here. Push lightly on the area shown in the figure to open the cover.

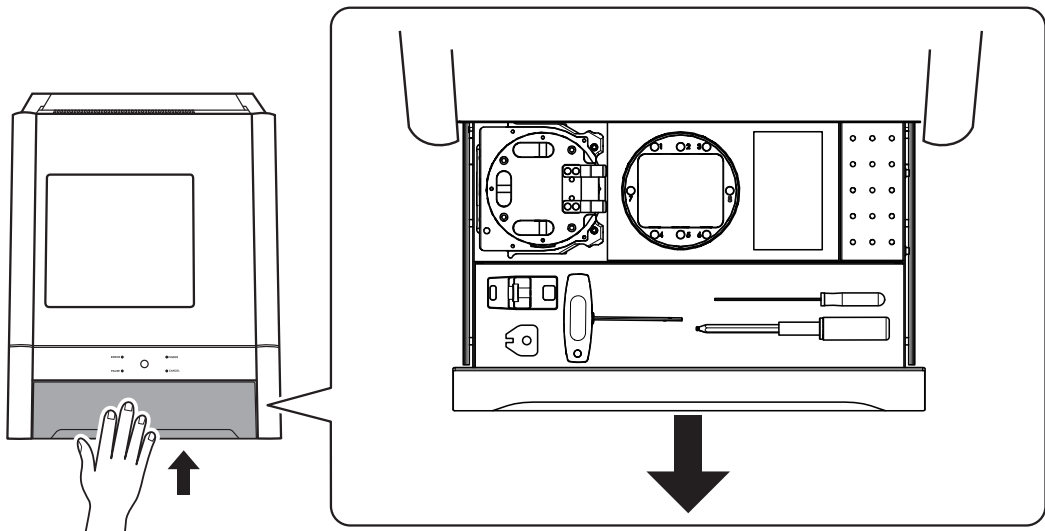

Back

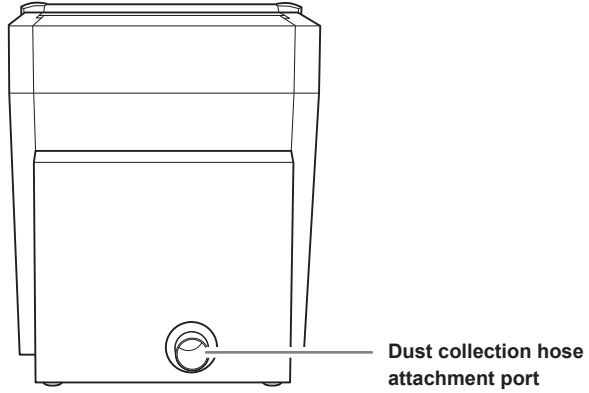



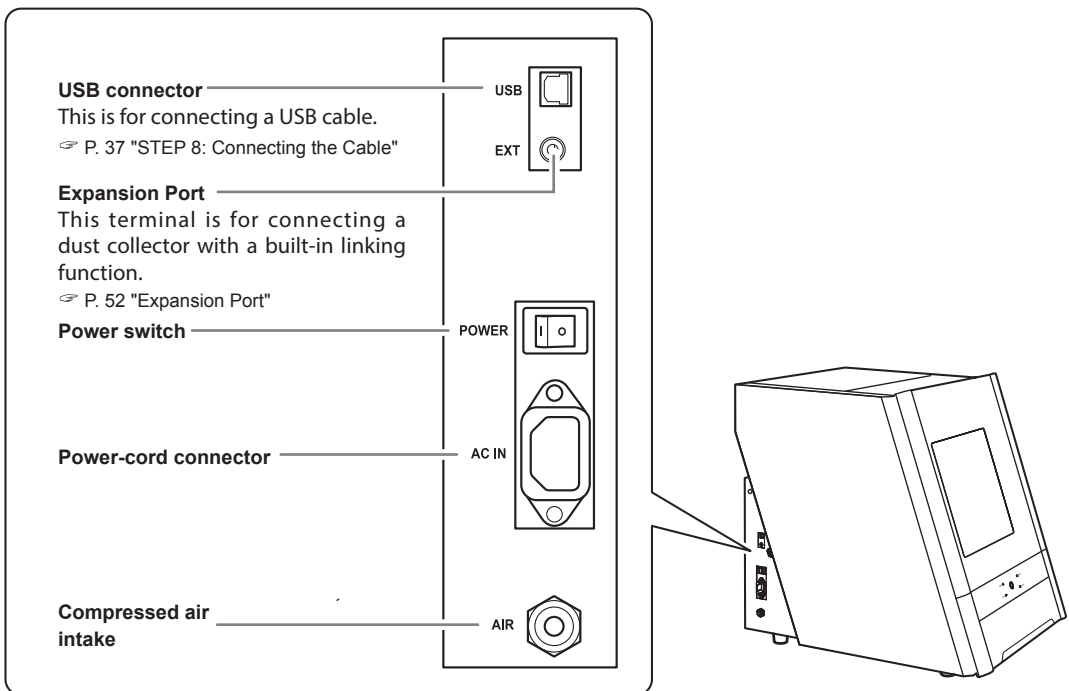







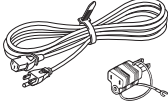

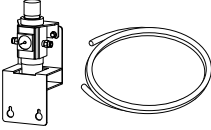

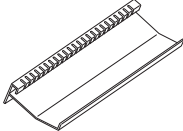
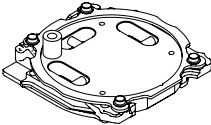
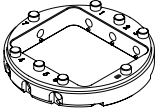
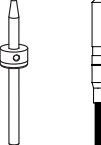
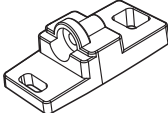
Side

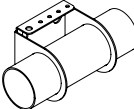

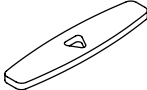
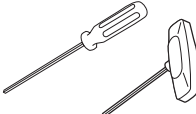
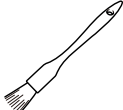
Preparing the Machine for Use

STEP 1: Checking the Included Items

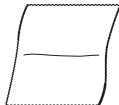
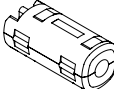
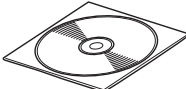
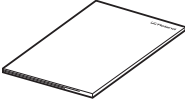
The following items are included with the machine. Make sure they are all present and accounted for.

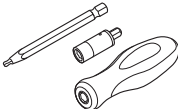
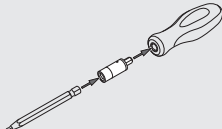
 <p>Power cord, power plug adapter (1 each)</p>	 <p>USB cable (1)</p>	 <p>Regulator (1) Air hose (1)</p>	 <p>Adapter (6)</p>
 <p>Adapter rack (1)</p>	 <p>Automatic correction jig (1)</p>	 <p>Pin-type material adapter (1)</p>	 <p>Detection pin (1) Cleaning tool (1)</p>
 <p>Milling bur positioner (1)</p>	 <p>Milling bur holders (16)</p>	 <p>Dust collection hose adapter (1)</p>	 <p>Dust collection hose (long/short; 1 each)</p>
 <p>Wrench (for clamps; 1)</p>	 <p>Wrench (for spindles; 1)</p>	 <p>Hexagonal screwdriver (1) T-shaped hexagonal screwdriver (1)</p>	 <p>Brush (1)</p>
 <p>Mounting screw (30)</p>	 <p>Screw (adapter spare; 8)</p>	 <p>Screw (pin-type workpiece adapter spare; 2)</p>	 <p>Screw (for regulator and dust collection hose adapter; 4)</p>
 <p>Cloth for care (1)</p>	 <p>Ferrite core (1)</p>	 <p>DGSHAPE Software Package CD (1)</p>	 <p>Setup Guide (this document; 1)</p>
 <p>Adapter ID labels (optional; 1)*</p>	 <p>Torque screwdriver (1)</p>	<p>Torque screwdriver Before use, assemble it as shown in the figure.</p> 	

* Use these labels when you have purchased optional adapters.

STEP 2: Preparing Separate Items

Dust collector

IMPORTANT!

This machine requires a dust collector for sucking up milling waste generated from milling. Milling cannot be performed without a dust collector.

⚠ WARNING

Be sure to turn on the dust collector.

Milling waste and workpieces are flammable and toxic.

⚠ WARNING

Never use a vacuum cleaner to clean up milling waste.

Taking up fine cuttings using an ordinary vacuum cleaner may result in fire or explosion.

The dust collector must meet the following conditions.

- **Static pressure: 4 kPa or more**
- **Air flow: 2 m³/min or more**
- **Dust collection hose: Use the included hose.**

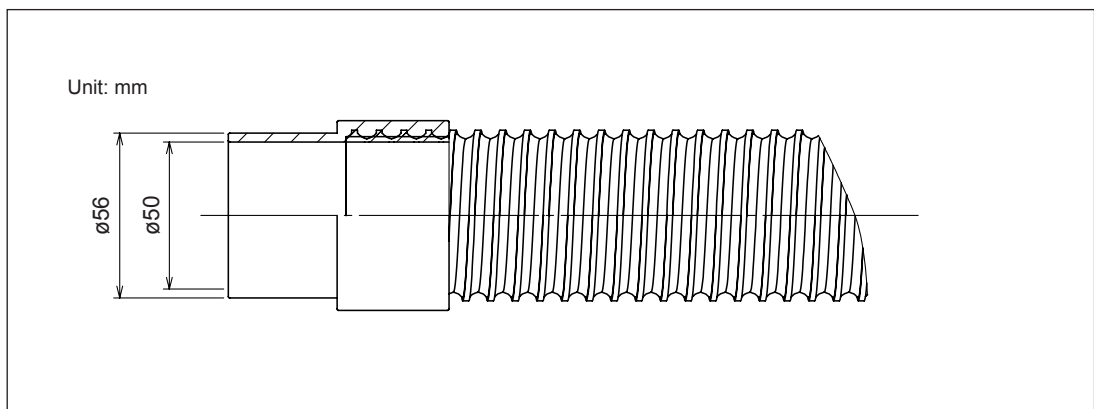

Compressor (Source of Compressed Air)

This machine requires compressed air. You will need to prepare a compressor separately.

- ⚠ WARNING** **The pressure of the compressed air must be 1.0 MPa or less.**
Anything higher may result in a serious accident such as a rupture.

- ⚠ WARNING** **Ensure that the supplied compressed air is not contaminated with water, oil, chemicals, or foreign objects.**
The components may deteriorate or rupture, or the contaminants may be scattered, posing a hazard.

- ⚠ WARNING** **Do not supply the compressed air until the air hose is connected securely.**
Failure to do so may cause an accident.

The compressor must meet the following conditions.

- **Control pressure: Between 0.3 and 1.0 MPa**
- **Air capacity: 30 L/min or more (for one machine)**
- **Oil-free type (To prevent contamination of the compressed air by foreign material.)**
- **Dryer-equipped (To prevent moist air that can cause rust.)**

Air Hose

The air hose (1) connects the compressor to the regulator.

The air hose must meet the following conditions.

- **Hose outer diameter: 6 mm (polyurethane resin tube)**

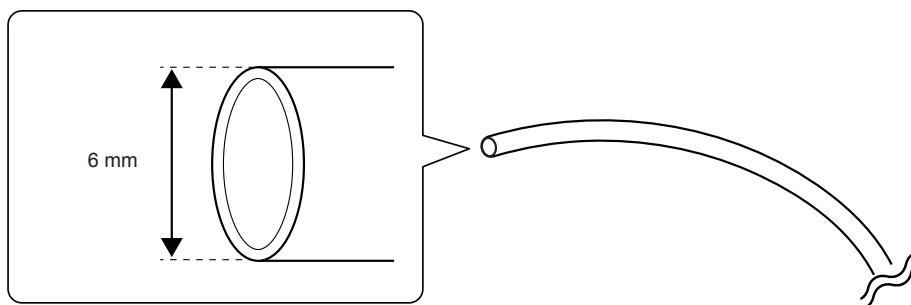

Note

Be sure to use the included regulator to supply compressed air.

For information on the compressed air pressure for each workpiece, see the "User's Manual (electronic-format manual)" ("Preparing Compressed Air (Setting the Regulator)" in "Preparing for Milling").

STEP 3: Deciding on an Installation Site

Placement and Installation

The weight of the machine alone is 67 kg (148 lb.) Unload and place the machine with care.

- ⚠ WARNING** Unloading and placement are operations that must be performed by 4 persons or more.
Tasks that require undue effort when performed by a small number of people may result in physical injury. Dropping the machine may result in injury.
- ⚠ CAUTION** When lifting the machine, hold the locations shown in the figure.

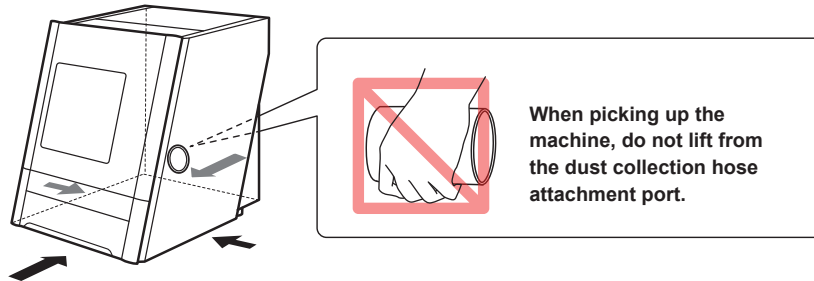

Installation Environment

- ⚠ WARNING** Install the machine in a location that is level, stable, and able to bear the weight of the machine.
The total weight of the machine may reach 70 kg (155 lb.) or more. Installation in an unsuitable location may cause a major accident, including tip over, fall, and collapse.
- ⚠ WARNING** Never install the machine in a location exposed to open flame.
Milling waste may ignite. Powdered material is extremely flammable, and even metal material may catch fire.
- ⚠ WARNING** Never install the machine close to any flammable object or in a gas-filled location.
Combustion or explosion may occur.
- ⚠ WARNING** Never install this machine outside or in any location where exposure to water or high humidity may occur.
Doing so may result in fire or electrical shock.
- ⚠ WARNING** Position the machine so that the power plug is within immediate reach at all times.
This is to enable quick disconnection of the power plug in the event of an emergency. Install the machine next to a power outlet. Also, provide enough empty space to allow immediate access to the power outlet.
- Never install the machine in a location subject to wide fluctuations in temperature or humidity.
 - Never install the machine in a location subject to shaking or vibration.
 - Never install the machine in a dusty or dirty location.
 - Never install the machine in a location exposed to direct sunlight or near air-conditioning or heating equipment.
 - Never install the machine in a location exposed to considerable electrical or magnetic noise or other forms of electromagnetic energy.
 - Never install the machine in an environment where silicone substances (oil, grease, sprays, etc.) are present. Doing so may cause poor switch contact or ionizer damage.

STEP 4: Removing the Retainers

Retainers are attached to the machine to protect it from vibration during shipment. When installation is complete, remove and save these retainers.

- Remove all the retainers. Any that remain may cause faulty operation or a breakdown when the power is switched on.
- The retainers are required when moving the machine to a different location. Store them carefully so that they do not get misplaced.

Removing the Retainers

Make sure the power cord is not connected, and then remove retainers A, B, and C in this order.

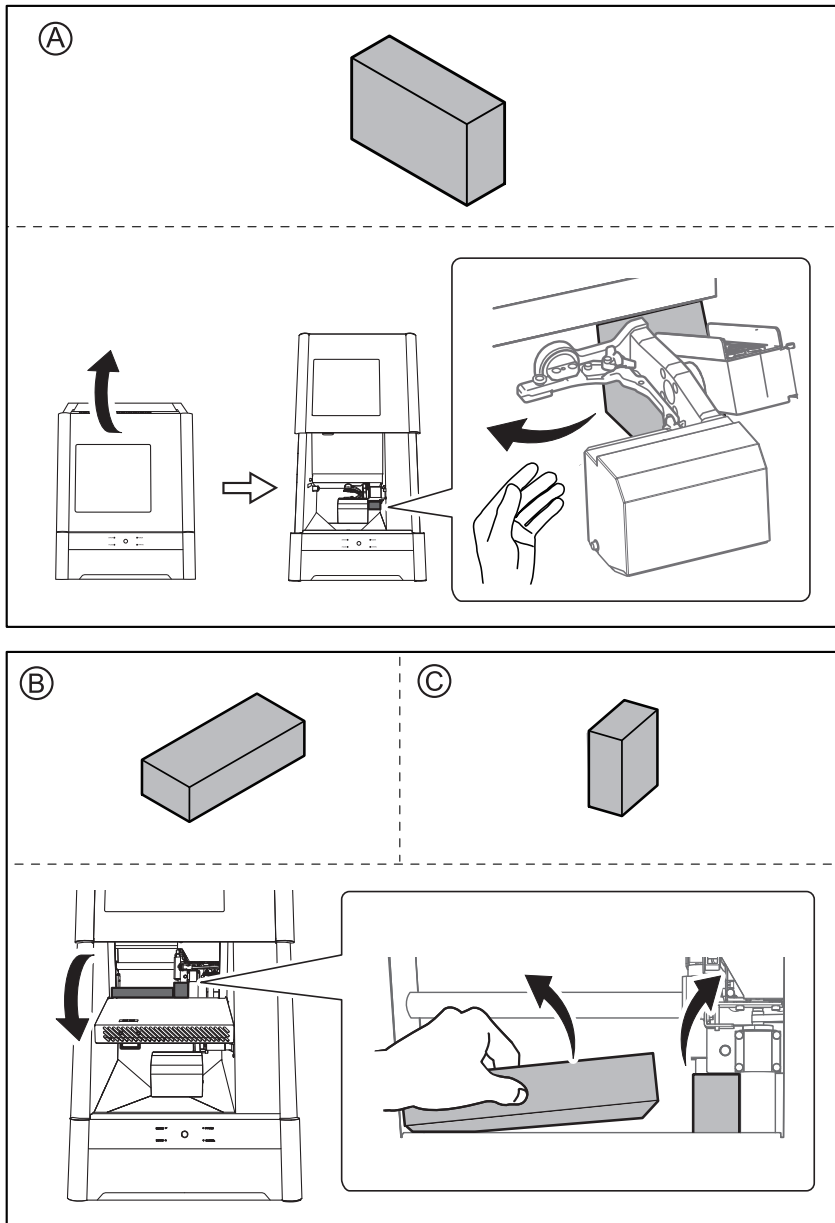

Installation space

Ensure that at least the following amount of space is available.

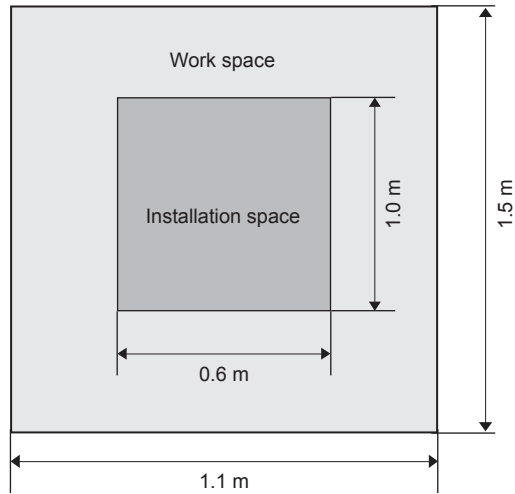

Ensure that enough space is available to allow the front cover to be opened.

Ensure that space is available in front of and behind the machine to enable the opening of the bottom cover.

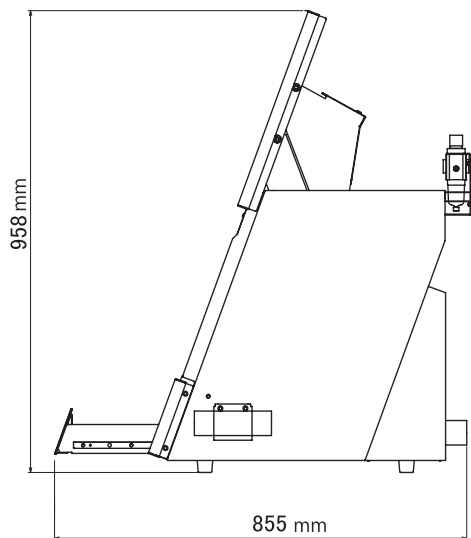

Installation Location Height

The installation location should be above the work floor by 0.6 m (23.6 in.) or more.

This machine is a desktop-type unit. Install the machine in a location that allows easy access to areas such as the power switch during operation.

STEP 5: Attaching the Dust Collection Hose

Connecting the Dust Collector Directly to the Machine

Attach the dust collection hose as shown in the figure.

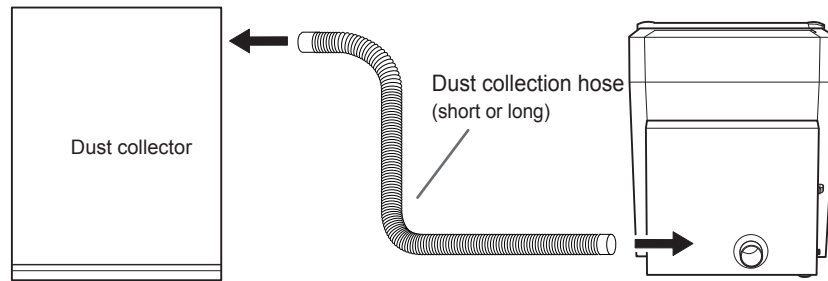

Using the Dust Collection Hose Adapter

Locations where the dust collection hose adapter can be attached

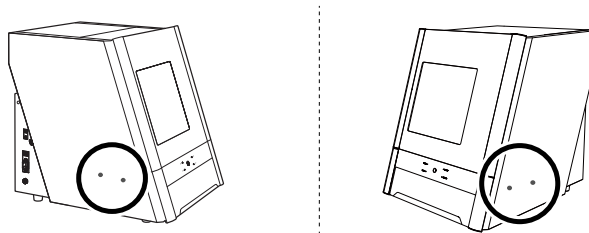

Procedure

- 1 ① Temporarily tighten the screws on the right and left sides (for the regulator and the dust collection hose adapter). (2 locations)

Use the torque screwdriver to turn the screws approximately 3 times.

- ② Align the holes of the dust collection hose adapter to the screws in step ①.

- ③ Use a torque screwdriver to fully tighten the screws. (2 locations)

Tighten the screws until turning the handle of the torque screwdriver no longer turns the screw bit.

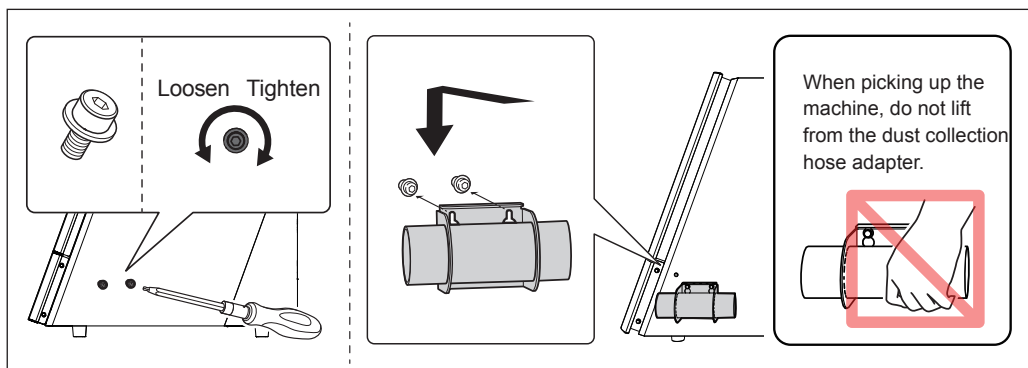

- 2 Attach the dust collection hose as shown in the figure.

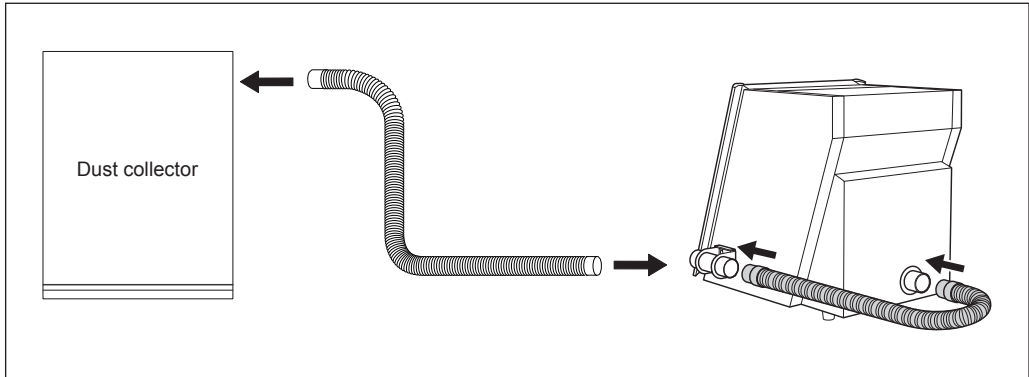

Dust Collector with Built-in Linking Function

Procedure

- 1 Attach the ferrite core to the linking cable included with the dust collector.

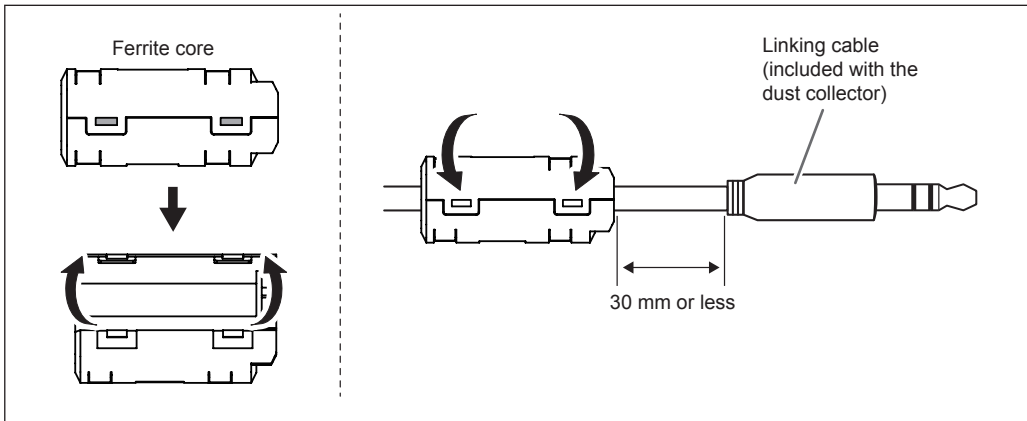

- 2 Insert the linking cable into the expansion port.

Secure the cable with a cable clamp.

☞ P. 52 "Expansion Port"

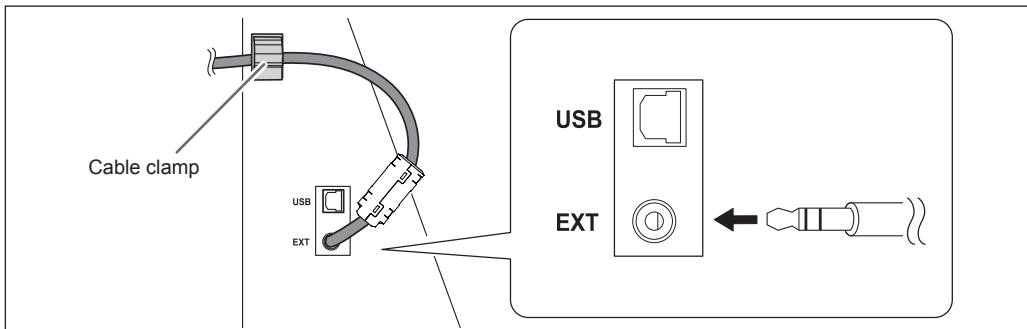

STEP 6: Attaching the Regulator

- ⚠ WARNING** Do not supply the compressed air until the air hose is connected securely. Failure to do so may cause an accident.

1. Attach the regulator to the machine.

- 1** Temporarily tighten the screws (for the regulator and the dust collection hose adapter) on the back of the machine. (2 locations)

Use the torque screwdriver to turn the screws approximately 3 times.

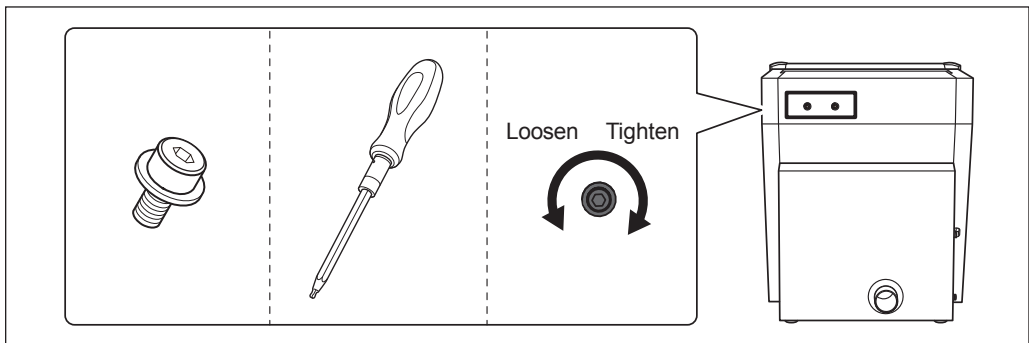

- 2** Align the holes of the regulator to the screws in **1**, and then fully tighten the screws using a torque screwdriver.

Tighten the screws until turning the handle of the torque screwdriver no longer turns the screw bit.

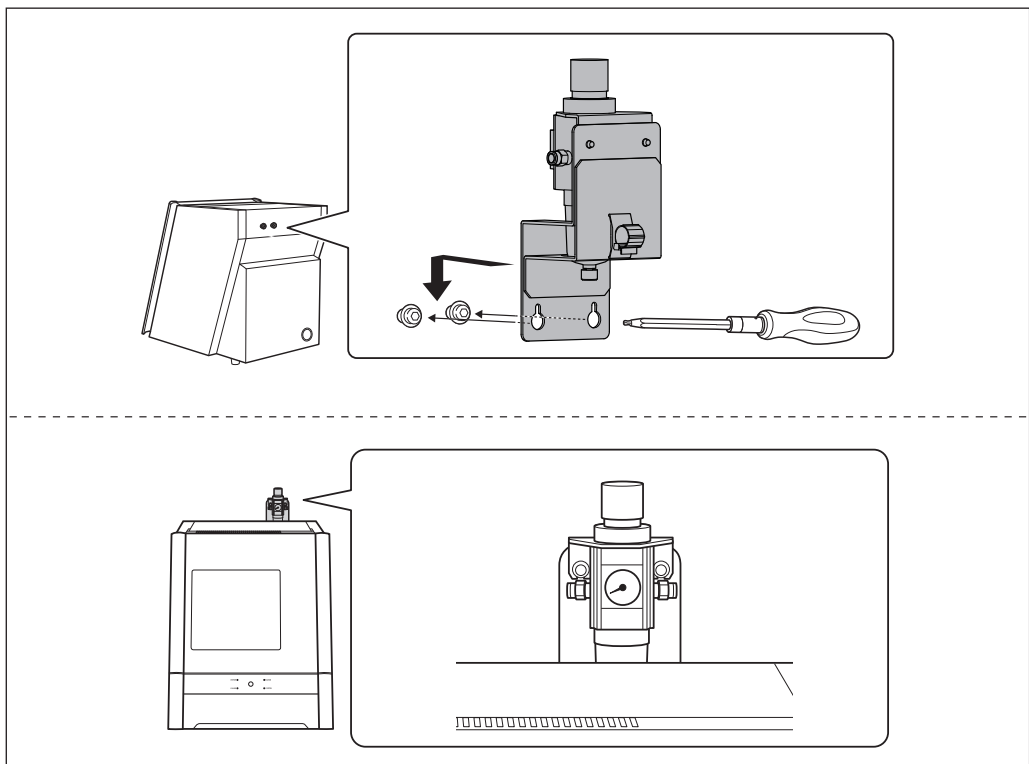

3 Attach the air hose to the regulator.

⚠ WARNING

Securely insert the air hose as far as it will go. Lightly tug on the hose to make sure it does not come loose. If it is not inserted securely, it may come loose.

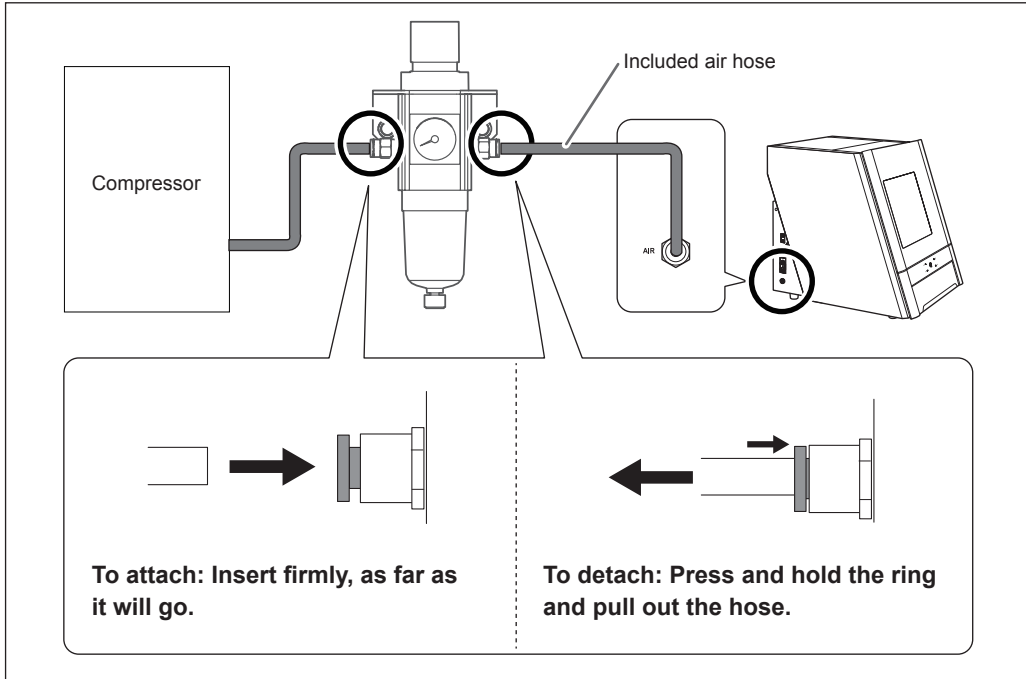

4 Supply compressed air and verify that air does not leak from the connections or any other location.

2. Set the air pressure to 0.2 MPa.

When CAM data is sent to the machine, it automatically adjusts the air pressure to match the workpiece to mill.

1 Pull up on the upper knob (the air pressure adjustment knob).

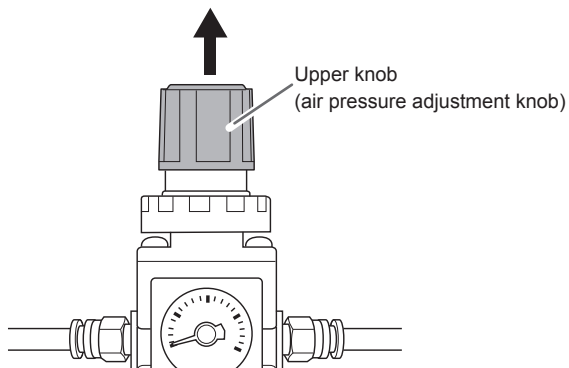

- 2 Slowly turn the upper knob to adjust the air pressure to 0.2 MPa.

⚠ CAUTION

Turn the air pressure adjustment knob slowly and carefully. Otherwise, the machine may move suddenly, posing a risk of injury.

IMPORTANT!

Be sure to adjust the air pressure setting to 0.2 MPa. The air pressure exceeding 0.2 MPa may result in a malfunction.

If the pressure is too low, the desired results will not be obtained.

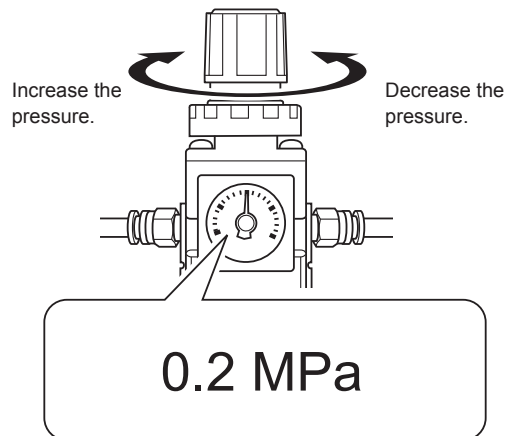

- 3 Push down on the upper knob.

STEP 7: Installing the Software

System Requirements

Operating system (OS)	Windows 10, 8.1 (32-bit and 64-bit versions)
CPU	Minimum required CPU for the operating system
Memory	Minimum amount of required RAM for the operating system
Optical drive	CD-ROM drive
Video card and monitor	A monitor with at least 256 colors and a resolution of 1024 × 768 or more is recommended.

- This software is a 32-bit application and therefore runs in WOW64 (Windows-On-Windows 64) when running on 64-bit versions of Windows operating systems.

For the latest information, see the DGSHAPE Corporation website (<http://www.dgshape.com/>).

Installable Software

VPanel for DWX	This is the dedicated software for controlling this machine. This software is used to operate this machine and to configure various settings. (Hereinafter, this software is referred to as "VPanel.")
Dental Driver (DWX-52D driver)	This is a Windows-based driver required for sending data from a computer to the machine.
DWX-52D Manual (electronic-format manual)	This manual explains how to operate the software, how to perform milling using this machine, and how to perform maintenance.

Installation Procedure

You can install the driver, software, and electronic-format manual all at once. You can also install them separately.

- "User's Manual" (electronic-format manual) "Installing Driver Separately"

IMPORTANT!

Be sure to connect the machine to the computer as instructed in the procedure. Failure to follow the correct procedure may make installation impossible.

Procedure

- 1** Before installation, confirm that the machine and the computer are not connected with the USB cable.
- 2** Log on to Windows as the computer's administrator (or as an "Administrators" account).
- 3** Insert the DGSHAPE Software Package CD into the CD-ROM drive of the computer.
When the automatic playback window appears, click [Run menu.exe]. If a [User Account Control] window appears, click [Allow] or [Yes], and then continue with the installation. The setup menu screen appears automatically.



Click [Install].

Install the DWX-52D driver and the various software all at once. Follow the on-screen instructions to proceed with the installation.

☞ P. 34 "Installable Software"

5

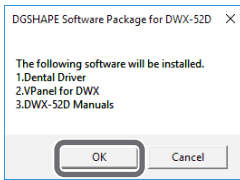

Click [OK].

6

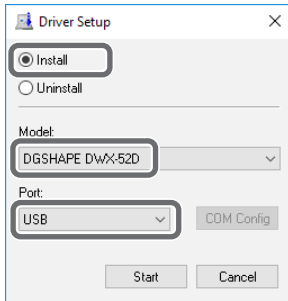

Click [Install], select "DGSHAPE DWX-52D" for the model name and "USB" for the port, and then click [Start].

The driver installation begins. Proceed with the installation by following the displayed information.

7

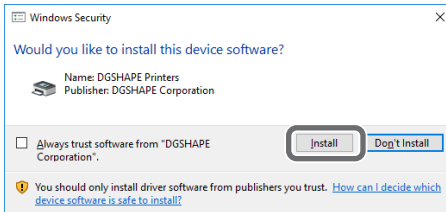

When the screen shown in the figure is displayed, click [Install].

8

When the installation is finished, remove the DGSHAPE Software Package CD from the computer.

How to View the Electronic-Format Manual

Windows 10

From the [Start] menu, click [DGSHAPE DWX-52D]. Then click [User's Manual].

Windows 8.1

On the [Start] screen, click . On the [Apps] screen, click the [User's Manual] icon under [DGSHAPE DWX-52D].

You can view and download the electronic-format manual from the following URL or QR code.

<https://downloadcenter.rolanddg.com/DWX-52D>

- * You can also view and download the paper manuals.
- * You can also view this website from a smartphone.



STEP 8: Connecting the Cable

Connecting the Power Cord

- ⚠ WARNING** Connect to a power outlet that complies with this machine's ratings (for voltage, frequency, and current).
Incorrect voltage or insufficient current may cause fire or electrical shock.
- ⚠ WARNING** Handle the power cord, plug, and power outlet correctly and with care. **Never use any article that is damaged.**
Using a damaged article may result in fire or electrical shock.
- ⚠ WARNING** When using an extension cord or power strip, use one that adequately satisfies the machine's ratings (for voltage, frequency, and current).
Use of multiple electrical loads on a single power outlet or use of a lengthy extension cord may result in fire.
- ⚠ WARNING** Connect the machine to ground.
This can prevent fire or electrical shock due to electric leakage in the event of a malfunction.
- ⚠ WARNING** Connect the machine to a power outlet. **Never connect this machine directly to a power distribution panel or other such fixed wiring equipment.**
Doing so increases the risk of fire or electrical shock.

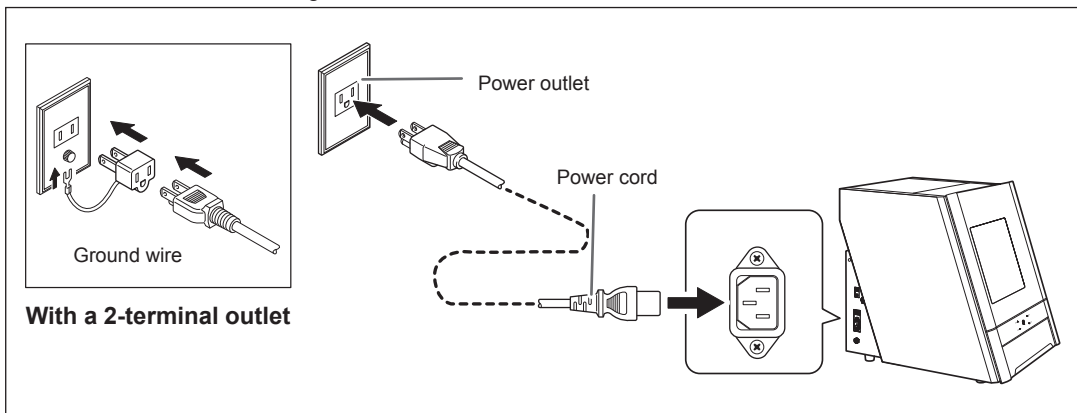

IMPORTANT!

The machine ID needs to be changed when connecting more than one machine. If you connect more than one unit of this machine to a single computer, be sure to follow the procedure given on P. 48 "Connecting Multiple Units". Connecting before changing the ID may render the machine unusable.

STEP 9: Switching On the Power Switch

Procedure

1

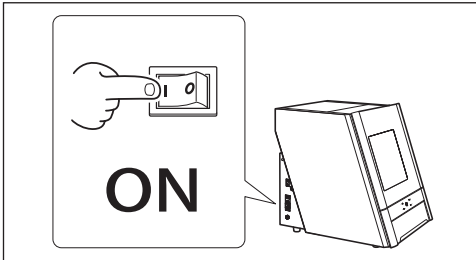

Switch on the machine's power switch.

The initial operations start.

2

Connect the machine to the computer using the USB cable.

- If connecting more than one unit of this machine to a single computer, refer to P. 48 "Connecting Multiple Units".
- Use the included USB cable.
- Do not use a USB hub. Connection may not be possible.
- Secure the USB cable with a cable clamp.

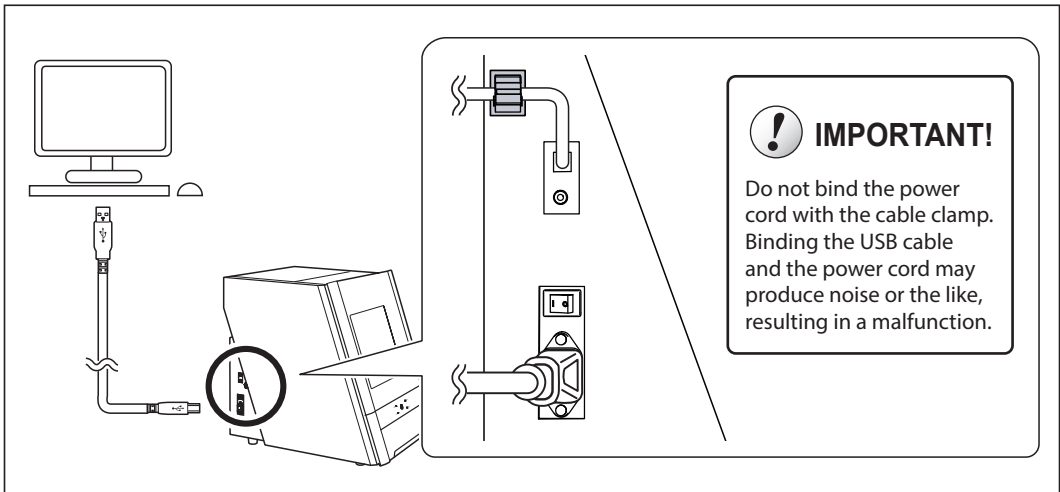

The driver will be installed automatically.

STEP 10: Selecting the Machine to Operate with the Control Software

Procedure

1 Start VPanel.

Windows 10

From the [Start] menu, click [VPanel for DWX]. Then click [VPanel for DWX].

Windows 8.1

① On the [Start] screen, click .

② On the [Apps] screen, click the [VPanel for DWX] icon under [VPanel for DWX].

2 Select the machine to operate.

Click the image of the DWX-52D displayed in the [Usable machine list].

The machine that will be operated from VPanel is displayed in the lower area.

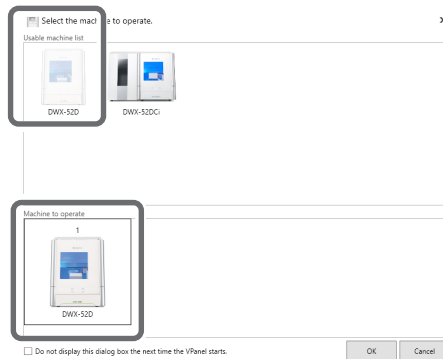

If you do not want to display the [Select the machine to operate.] screen when VPanel starts, select the [Do not display this dialog box the next time the VPanel starts.] check box.

3 Click [OK].

STEP 11: Running In the Spindle

Procedure

1 Close the front cover and turn on the power.

When the initial operations finish, open the front cover and load the detection pin in the ATC magazine's number 15 position.

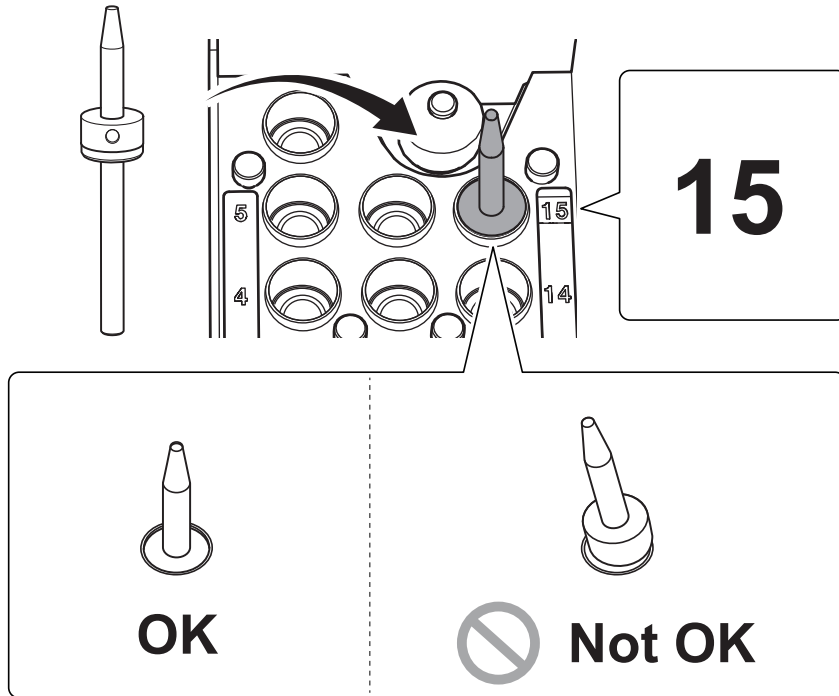

2 Show VPanel.

☞ P. 39 "STEP 10: Selecting the Machine to Operate with the Control Software"

3

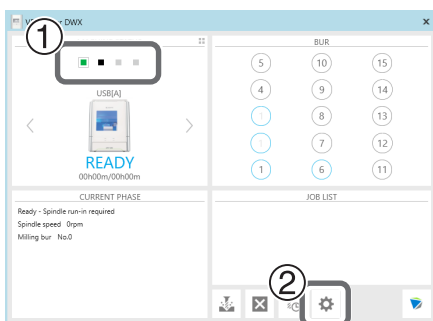

1 In the top window of VPanel, select the machine to operate.

When multiple machines are connected, click the ■ icons under MACHINE STATUS to switch between the machines.

2 Click [Settings].

The [Settings] screen will appear.

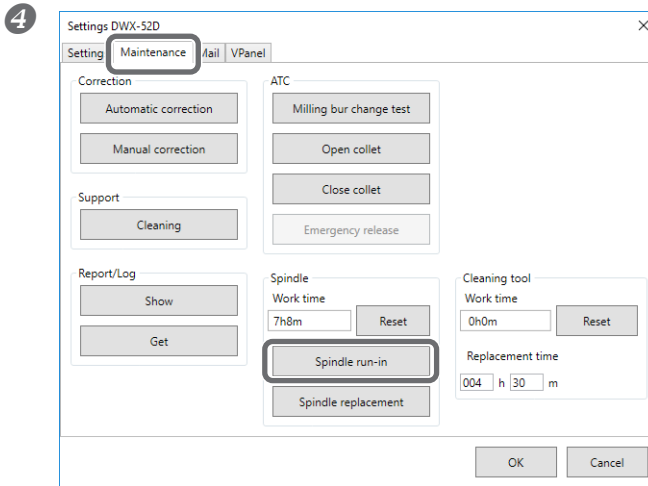

Click the [Maintenance] tab, and then click [Spindle run-in].

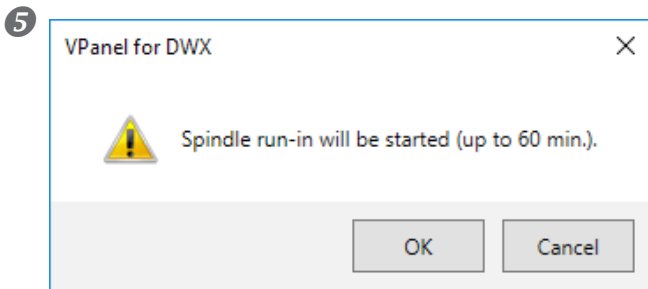

Click [OK].
Run-in will begin.
This step is complete once the message indicating that the operation is complete appears.
Continue on to "STEP 12: Performing Automatic Correction."

STEP 12: Performing Automatic Correction

Perform automatic correction for the ATC magazine position and the rotary axis position.

Required Items

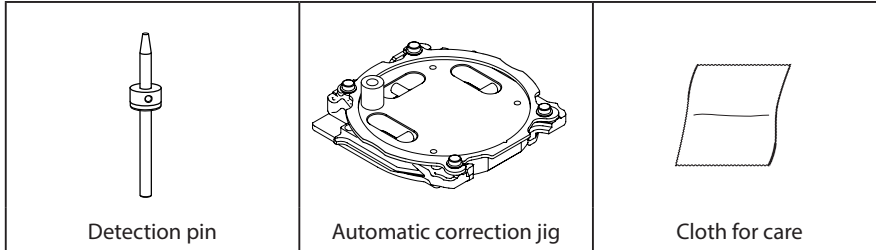

1. Install the detection pin.

- 1 Remove any debris that is present around the clamp.
- 2 Use the included cloth for care to wipe clean the parts indicated in the following figure as ① and ②.

If any dirt is present in these locations, it may not be possible to perform the correction properly.

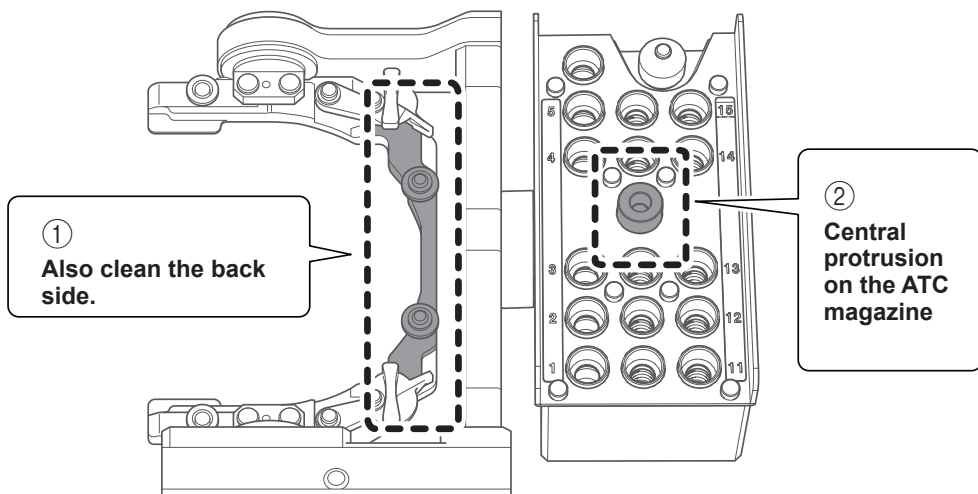

- 3 Use the included cloth for care to wipe clean the automatic correction jig and the detection pin. If any dirt is present in these locations, it may not be possible to perform the correction properly.



Detection pin

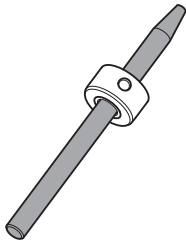

Automatic correction jig

Also clean the back side and the shaft.

Front

Shaft

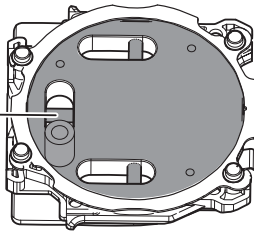

Back

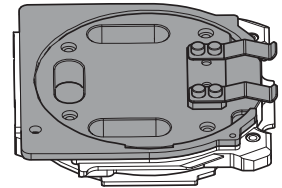

- 4 Load the detection pin in the ATC magazine's number 15 position.

Insert the detection pin firmly.

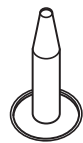
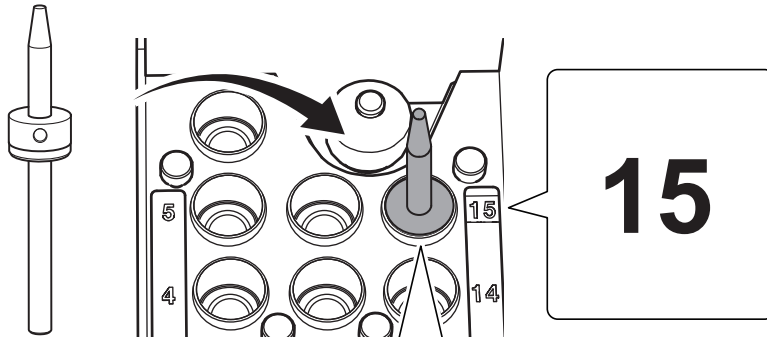

OK



Not OK

2. Attach the automatic correction jig.

- 1 Insert the automatic correction jig into the clamp as shown in the figure.

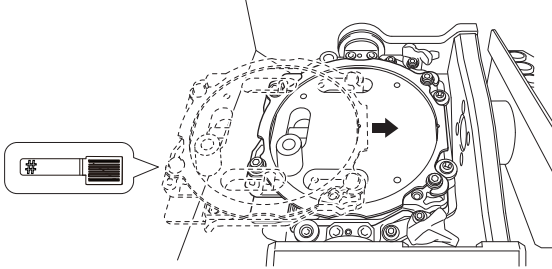

- 2 Fix the automatic correction jig in place.

As shown in the figure, turn the fixing knobs (in two locations) in the directions of the arrows while pressing in on the automatic correction jig.

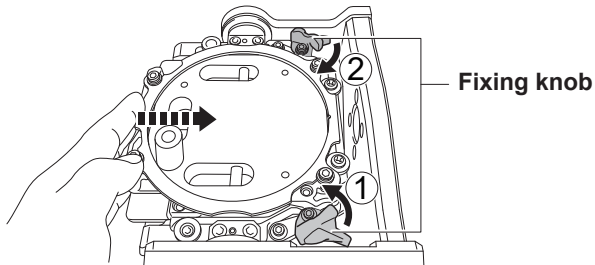

Point

If it is difficult to turn the knobs by hand, use the included wrench.

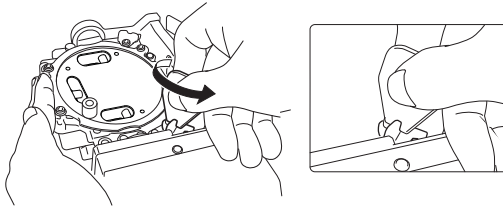

- 3 Lightly tug on the automatic correction jig to make sure it does not come loose.

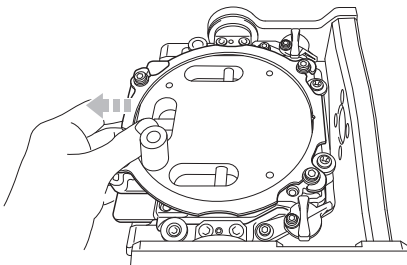

- 4 Close the front cover.

3. Perform automatic correction.

- 1 Show VPanel.

☞ P. 39 "STEP 10: Selecting the Machine to Operate with the Control Software"

- 2 Open the [Settings] screen.

- 1 In the top window of VPanel, select the machine to operate.

When multiple machines are connected, click the ■ icons under MACHINE STATUS to switch between the machines.

☞ P. 48 "Connecting Multiple Units"

- 2 Click .

The "Settings" window will appear.

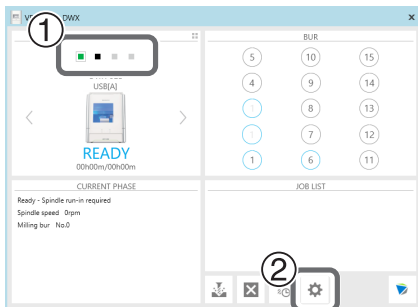

- 3 Click the [Maintenance] tab, and then click [Automatic correction].

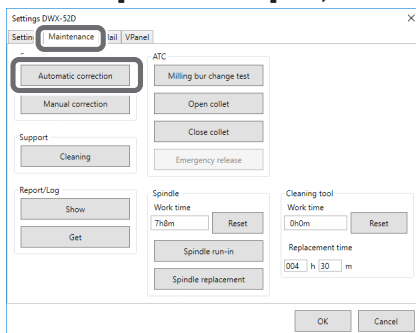

- 4 Check that the work displayed on the screen is complete.

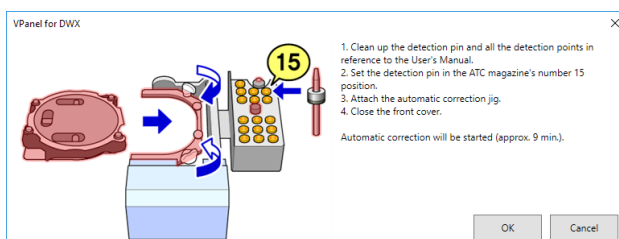

5 Click [OK].

Automatic correction starts.

6 When the screen shown in the figure is displayed, click [OK].

This completes the automatic correction.

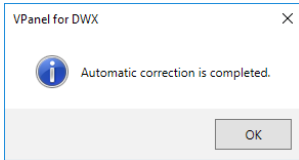

7 Once automatic correction is complete, remove the detection pin and the automatic correction jig.

Detection pin

Procedure

Open the front cover and remove the detection pin.

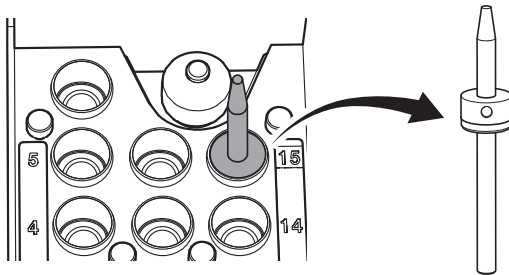

Automatic correction jig

⚠ CAUTION

Do not pull the adapter with excessive force when removing it.

Doing so may result in injury arising from your hand or arm hitting something.

Procedure

1 Turn the fixing knobs (in two locations) in the directions of the arrows to release the lock.

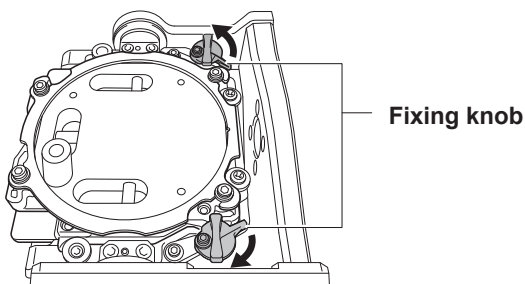

② **Remove the automatic correction jig.**

Hold the adapter with both hands and pull it out slowly.

Exercise caution to avoid striking the inside of the machine with your hands or other body parts when pulling out this part.

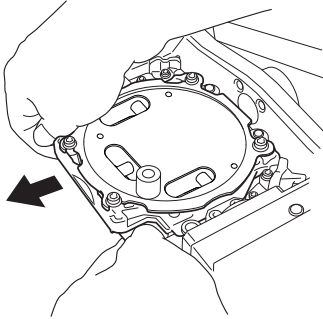

⑧ **Store the removed detection pin and automatic correction jig in the storage compartment.**

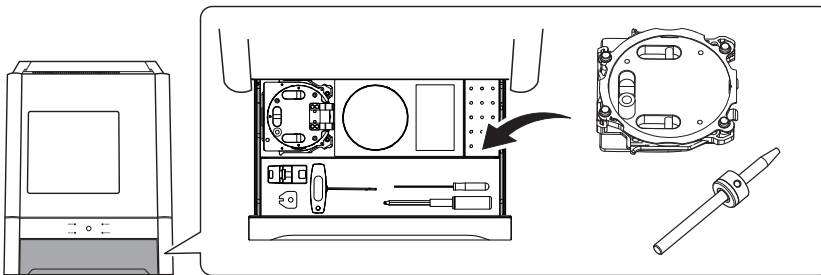

STEP 13: Switching Off the Power Switch

Procedure

Switch off the machine's power switch.

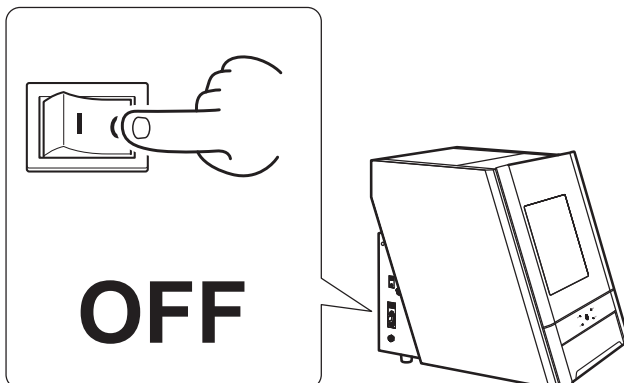

Connecting Multiple Units

Connection Method

Up to four machines can be concurrently connected to a computer. When more than one machine is connected, each machine needs to be identified on VPanel. An ID (A, B, C, and D) must be assigned to each machine to configure the settings for each machine.

The explanations in this section assume that one machine is already connected and describe how to connect one or more additional machines.

☞ P. 35 "Installation Procedure"

Procedure

1 Show VPanel.

☞ P. 40 "STEP 11: Running In the Spindle" step ②

2 Turn off the power of the connected machine, and then disconnect the USB cable from the computer.

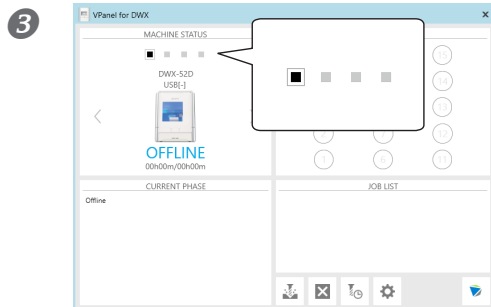

Check that the icons under MACHINE STATUS are displayed in black or gray.

4 Switch on the power of the machine to be newly connected, and connect the USB cable to the computer.

IMPORTANT!

Configure the connections one machine at a time. Be sure to connect only the machine to be configured. If you connect more than one machine with the same ID at the same time, the computer might shut down or make driver installation impossible.

Use the included USB cable.

Do not use a USB hub. Connection may not be possible.

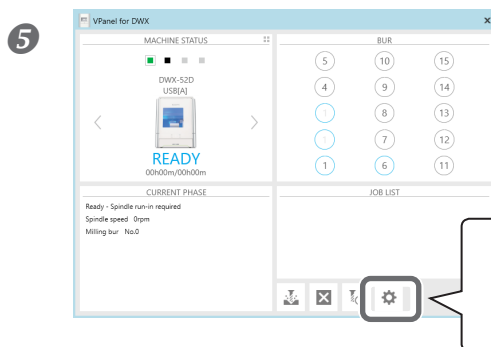

Click .

The [Settings] screen will appear.

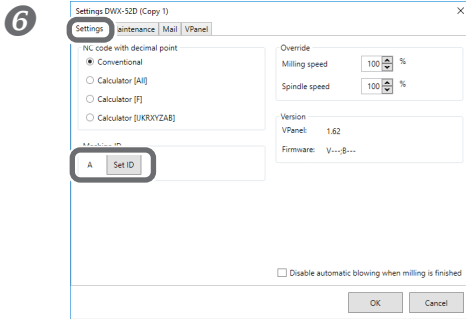

Click the [Settings] tab, and then click [Set ID].
The [Set ID] selection screen opens.

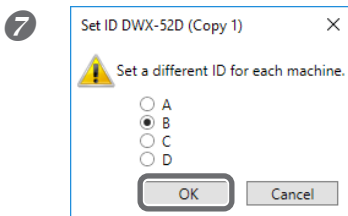

Select any unused ID, and click [OK].
"A" is assigned as the ID of the machine by default. Since A is assigned to the first machine, be sure to select B, C, or D for subsequent machines.

IMPORTANT!

Do not set duplicate IDs. If you connect more than one machine with the same ID at the same time, the computer might shut down or make driver installation impossible.

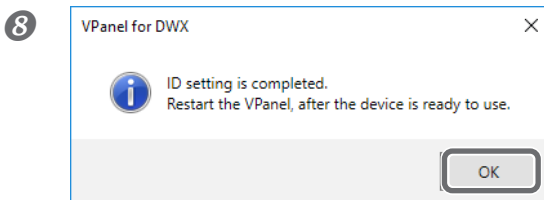

When the window shown to the left appears, click [OK].

The machine will restart. The driver for the machine with the new ID will be installed automatically.

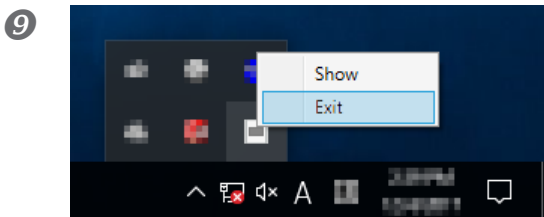

Exit VPanel.

Right-click  (the VPanel icon) in the task tray and select [Exit] to exit VPanel.

10 Start VPanel.

☞ P. 39 "STEP 10: Selecting the Machine to Operate with the Control Software"

The selected ID is now enabled. Check that the machine has been added under MACHINE STATUS. If the name of the machine has not been changed, "DWX-52D (Copy 1)" is displayed. ("DWX-52D (Copy 2)" is displayed for the third machine.)

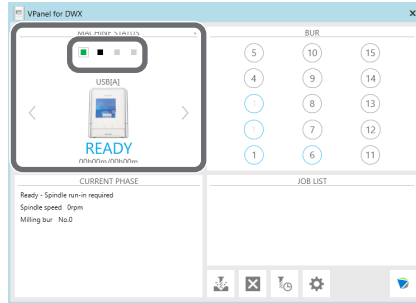



IMPORTANT!

You can connect all the machines with configured settings to the computer using USB cables. At this point, connecting more than one machine with the same ID at the same time may cause the computer to shut down.

Repeat steps 2 to 10 to connect a third or fourth machine.

Switching the Machine to Operate

When multiple machines are connected, you can operate the machines displayed under MACHINE STATUS. When switching between machines to operate, click  or  to display the machine that you want to operate. If the name of the machine has not been changed, "DWX-52D (Copy 1)" is displayed. ("DWX-52D (Copy 2)" is displayed for the third machine.)

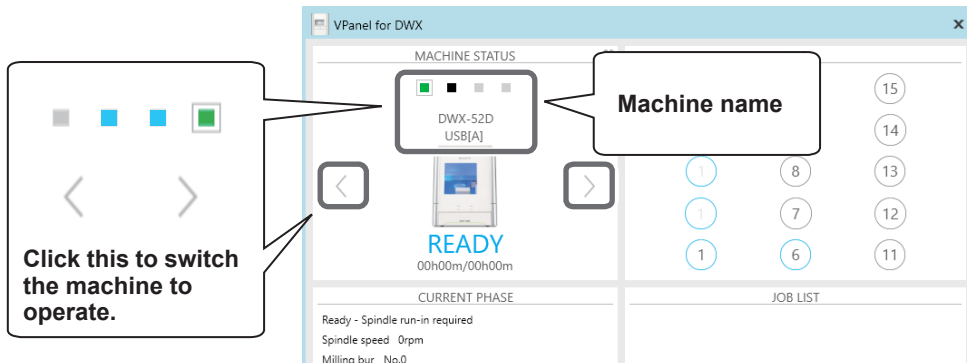

MEMO

To change the order in which machines are displayed, see ""VPanel" Tab" under "VPanel Window and Functions" in the "DWX-52D User's Manual."

Changing the Name and Screen of the Machine Displayed on VPanel

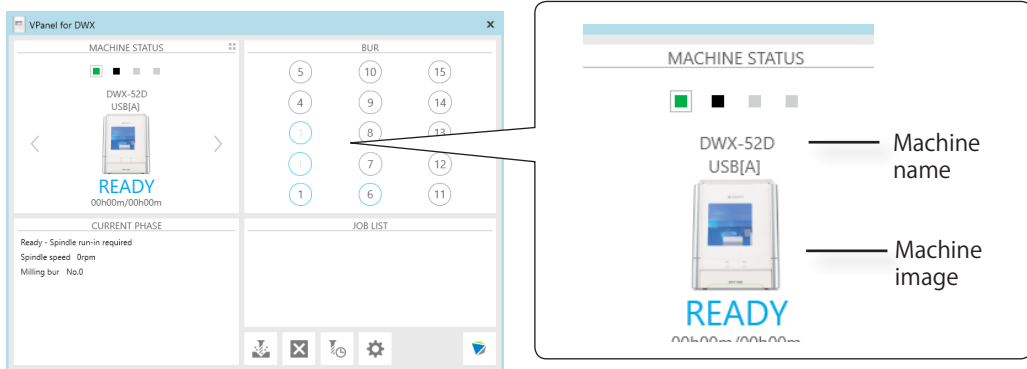

Changing the Name of the Selected Machine

Procedure

- 1 Open the [Devices and Printers] folder.

Windows 10

- 1 Click the [Start] menu on the computer.
- 2 Click [Windows System], and then click [Control Panel].
- 3 Click [Devices and Printers].

Windows 8.1

- 1 Right-click the [Start] menu on the computer.
- 2 Click [Control Panel].
- 3 Click [Devices and Printers].

- 2 Select the name of the model (printer) being used, and then change its name.

- 3 Restart VPanel.

The changed name appears on the top window.

Changing the Screen of the Machine Displayed on VPanel

Procedure

- 1 Display the top window of VPanel.
- 2 Right-click the image of the machine displayed under MACHINE STATUS, and then click [Change image].
- 3 On the "Open" screen, select the image file that you want to display.
The changed image is displayed in the top window.

Specifications

Expansion Port

IMPORTANT!

Before connecting or disconnecting the cable, be sure to turn off the machine's power. Connecting cables to or disconnecting cables from the milling machine while its power is on may cause malfunctions.

* We are not responsible for devices connected to this port.

PIN number	Signal	Overview/function
①	24 V	Ensure that the output does not exceed 100 mA.
②	ON SIGNAL	This signal operates during milling and during ATC operation.
③	N.C.	—

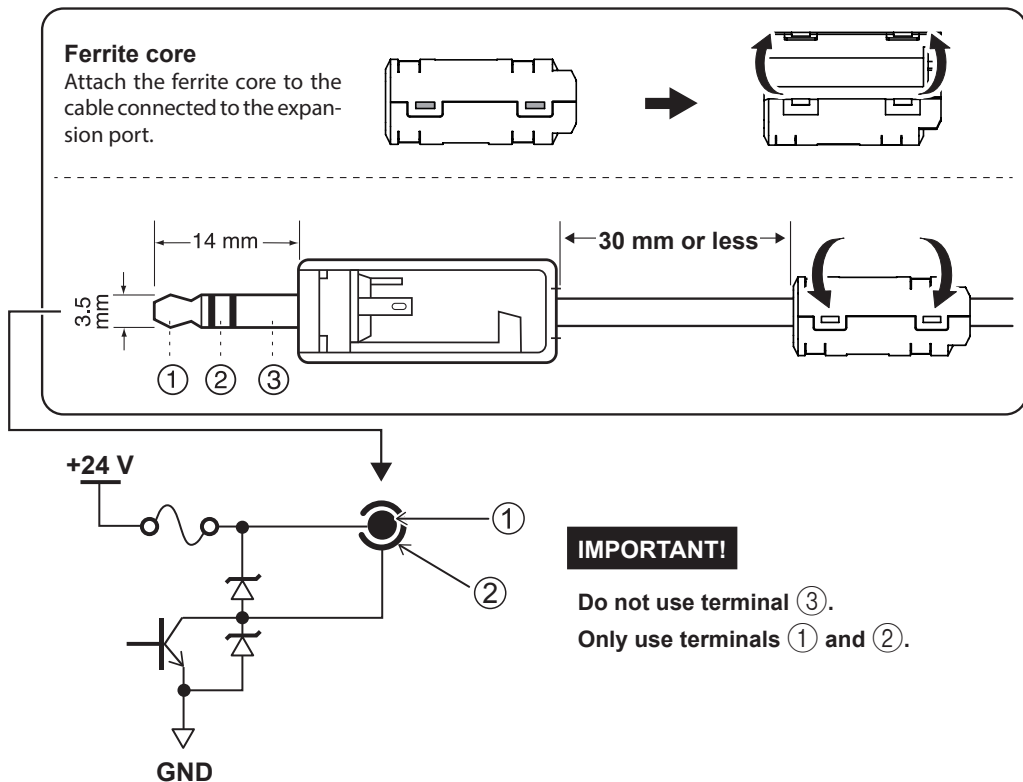

Note

- Be sure to use the connector within the rated range shown above.
- Do not apply an additional voltage to the connector.
- Do not short-circuit the connector to ground.

Power Rating and Serial Number Location

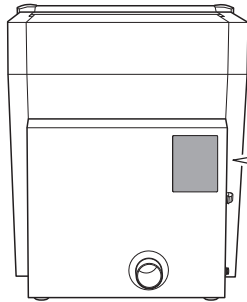

Serial number

The serial number is required for maintenance, servicing, and support. Never peel off the label.

Power rating

Use an electrical outlet that meets the ratings for voltage, frequency, and current given here.

Coordinates

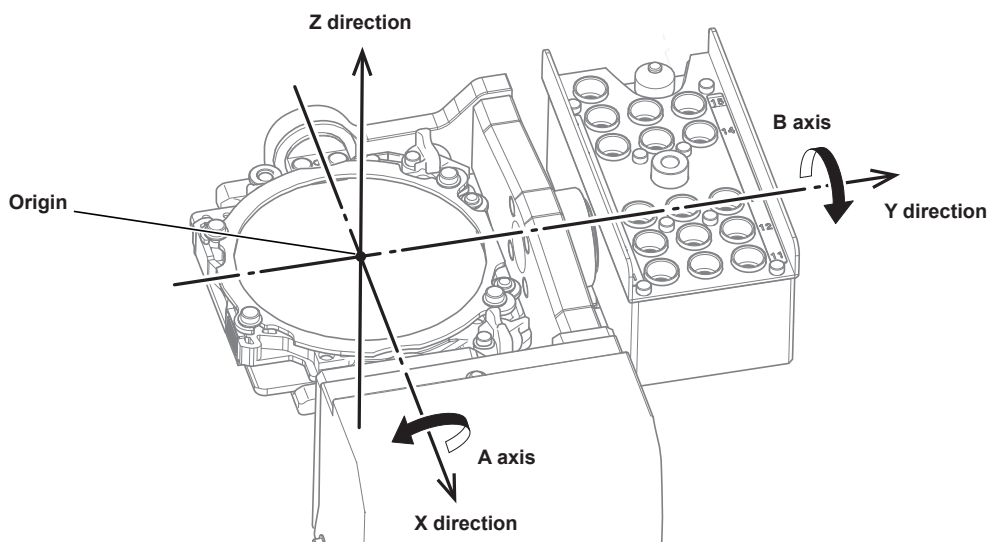

Dimensional Drawings

External Dimensions

Unit: mm

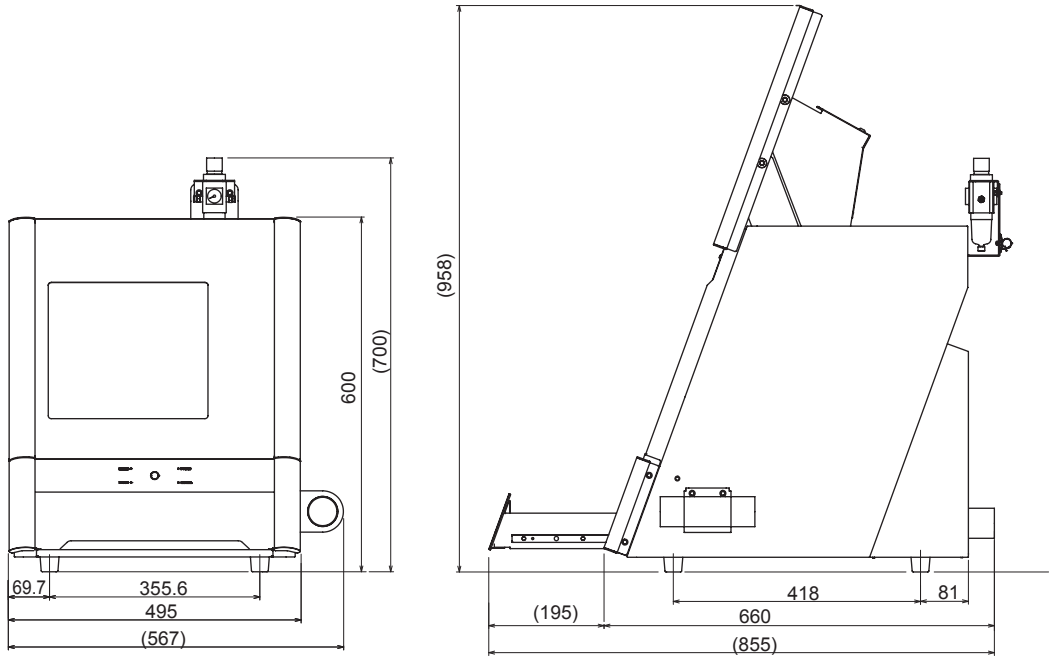

Pin-type Workpiece Adapter Dimensions

Unit: mm

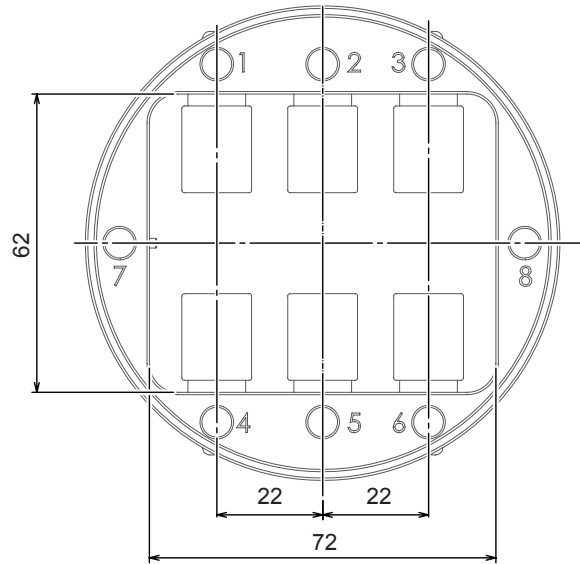

Detection Pin Dimensions

Unit: mm

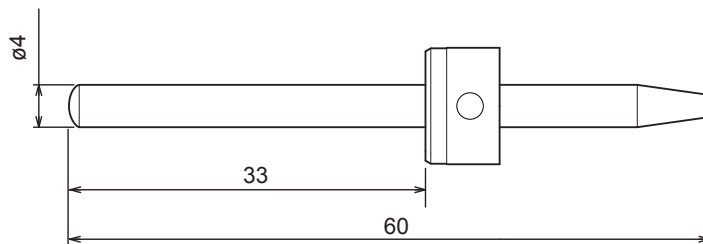

Cleaning Tool Dimensions

Unit: mm

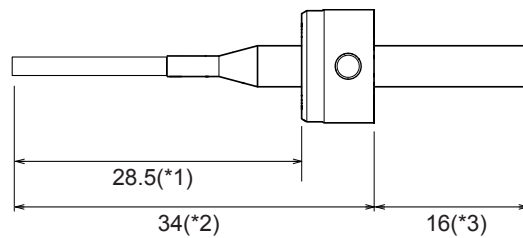

With the ZS-4D spindle
 *1: 28, *2: 35, *3: 15

Specifications

DWX-52D	
Millable material*	Zirconia PMMA, PEEK, composite resin Wax Dental non-cast cobalt-chromium alloy (zirconia, wax, PMMA, composite resin, PEEK, gypsum, glass-fiber-reinforced resin, CoCr sintered metal)
Loadable workpiece shape	Disk type (with step) Step section: 98.5 mm (diameter), 10 mm (height) Body section: 95 mm (diameter), 60 mm max. (height)
	Pin type Pin diameter: 6 mm
Operating speed	XYZ: 6 to 1800 mm/min (0.24 to 70.9 in./min)
Spindle motor	Brushless DC motor
Spindle speed	6,000 to 30,000 rpm
Rotary axis travel angle	A: $\pm 360^\circ$, B: $\pm 30^\circ$
Number of milling burs housed	15
Attachable milling bur	Shank diameter: 4 mm, length: 40 to 55 mm
Compatible compressed air	0.02 to 0.2 MPa
Interface	USB
Control command sets	RML-1, NC code
Power requirements	100 VAC \pm 10%, 50/60 Hz (overvoltage category II, IEC 60664-1), 2.0 A
Power consumption	Approx. 200 W
Operating noise	During operation: 70 dB (A) or less (when not cutting), during standby: 45 dB (A) or less
External dimensions	Width \times depth \times height: 495 \times 660 \times 600 mm (19.5 \times 26.0 \times 23.6 in.)
Weight	67 kg (148 lb.)
Installation environment	Indoor use at altitudes up to 2000 m (6561.68 feet) Temperature: 5 to 40°C, humidity: 35 to 80%RH (no condensation) Ambient pollution degree: 2 (as specified by IEC 60664-1) Short-term temporary overvoltage: 1440 V, long-term temporary overvoltage: 490 V
Included items	Power cord, power plug adapter, USB cable, manuals, DGSHAPE Software Package CD, detection pin, automatic correction jig, adapters, adapter rack, pin-type material adapter, hexagonal screwdrivers, wrench (for clamps), wrench (for spindles), milling bur holders, milling bur positioner, cleaning tool, optional adapter ID labels, dust collection hoses, dust collection hose adapter, regulator, brush, etc.

* Even when made from the described materials, some workpieces cannot be cut due to specifications or physical properties. For more information, contact your authorized dealer.

For China

产品中有毒有害物质或元素的名称及含量

部件名称	有毒有害物质或元素					
	铅(Pb)	汞(Hg)	镉(Cd)	六价铬 (Cr(VI))	多溴联苯 (PBB)	多溴二苯醚 (PBDE)
印刷电路板	×	○	○	○	○	○
头部	×	○	○	○	○	○
壳体、底架	×	○	○	○	○	○
电源	×	○	○	○	○	○
其他(电缆、附件等)	×	○	○	○	○	○

○：表示该有毒有害物质在该部件所有均质材料中的含量均在 GB/T26572-2011 标准规定的限量要求以下。
 ×：表示该有毒有害物质至少在该部件的某一均质材料中的含量超出 GB/T26572-2011 标准规定的限量要求。

环保使用期限



此标志适用于在中国国内销售的电子信息产品，表示环保使用期限的年数。所谓环保使用期限是指在自制造日起的规定期限内，产品中所含的有害物质不致引起环境污染，不会对人身、财产造成严重的不良影响。环保使用期限仅在遵照产品使用说明书，正确使用产品的条件下才有效。不当的使用，将会导致有害物质泄漏的危险。

For EU Countries



This product must be disposed of separately at your local waste recycling center. Do not dispose of in household waste bin.



Lever dit product in bij een lokaal afvalverzamelpunt. NIET met normaal huishoudelijk afval afvoeren.



Bitte führen Sie dieses Produkt separat Ihrer örtlichen Entsorgungsstelle zu. Bitte nicht mit dem normalen Hausmüll entsorgen.



Dette Produkt skal smides særskilt væk på den lokale affalds- og genbrugsstation. Må ikke smides ud sammen med almindeligt husholdningsaffald.



Ne jetez pas le produit avec vos ordures ménagères. Portez-le dans un centre recyclage des déchets.



Tätä tuotetta ei saa hävittää normaalien talousjätteiden mukana, vaan se on toimitettava ongelmajätteiden keräilypisteeseen hävitettäväksi.



Questo prodotto deve essere smaltito negli appositi contenitori per la raccolta differenziata, non buttare nel cestino dei rifiuti casalinghi.



Produkten måste kasseras separat på din lokala återvinningscentral. Släng inte produkten tillsammans med hushållssoporna.



Este producto debe devolverse al centro de reciclaje más cercano a su domicilio para su correcta eliminación. No lo tire a la basura.



Μην πετάξετε το αντικείμενο αυτό στο καλάθι των απορριμμάτων. Αφαιρέστε τις μπαταρίες και προσκομίστε το στο τοπικό κέντρο ανακύκλωσης.



Deite fora separadamente este produto no seu centro de reciclagem local. Não o deite fora no seu caixote do lixo.

MEMO

A series of horizontal dotted lines for writing, spanning the width of the page.

A series of horizontal dotted lines for writing.

MEMO

A series of horizontal dotted lines for writing.